

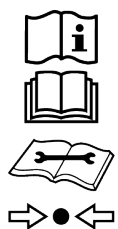

Installation Manual: R-454B Outdoor Split-System Single-Phase Heat Pump - YH5 and XH5 Series



Refrigerant
Safety Group
A2L

 **CAUTION**

Risk of fire

This unit uses a mildly flammable (A2L) refrigerant. See [A2L refrigerant safety considerations](#) to ensure safe installation, operation, and servicing of this unit.

York International Corporation, 5005
York Drive, Norman, OK 73069

6396605-UIM-C-0125

Supersedes: 6396605-UIM-B-0724

2025-01-23

Contents

About the unit.....	5
Certification.....	5
DS Solutions App.....	5
Safety.....	6
Understanding safety symbols and instructions.....	6
Safety requirements.....	7
A2L refrigerant safety considerations.....	8
General.....	8
Room size requirements.....	9
Mechanical ventilation.....	11
Refrigerant equipment checks.....	12
Electrical devices checks.....	12
Detection of refrigerant.....	13
Wiring installation.....	14
Installation overview.....	17
Preparing for installation.....	18
Selecting a location for installation.....	18
Inspecting the unit.....	20
Understanding installation and operation limitations.....	20
Meeting requirements for A2L equipment.....	20
Installing the outdoor unit.....	22
Setting the outdoor unit on the ground or on a roof.....	22
Mounting the outdoor unit on a wall.....	24
Installing the outdoor unit as a replacement unit.....	24
Installing the refrigerant piping.....	26
Installing the vapor and liquid lines.....	26
Installing the liquid line filter-drier.....	28
Connecting the refrigerant lines.....	28
Brazing the refrigerant lines and service valves.....	29
Using braze free refrigerant line connections.....	31
Installing the thermostatic expansion valve (TXV).....	32
Checking for refrigerant leaks.....	34
Evacuating the refrigerant lines and indoor coil.....	35
Releasing refrigerant into the system.....	35
Connecting the wiring.....	36
General information and grounding the unit.....	36
Completing the field power wiring connections.....	37
Completing the field control wiring connections.....	37
Control wiring diagrams.....	39
Using the optional S1-2HU16700124 dehumidification control.....	42

Charging the system.....	43
Measuring indoor airflow.....	44
Checking the indoor cubic feet per minute (CFM) settings.....	44
Determining the total system charge.....	44
Charging with gauges.....	45
Subcooling charging charts.....	46
Heating charging charts.....	53
Starting up the system.....	58
Energizing the crankcase heater (if applicable).....	58
Instructing the owner.....	59
Maintenance and repair.....	59
Required procedures for A2L systems.....	60
Decommissioning.....	61
Test input.....	62
System components and operation.....	64
Anti-short-cycle delay.....	64
Low voltage detection.....	64
Fault code display.....	64
Demand defrost.....	65
Operating demand defrost.....	65
Defrost curves.....	66
Defrost curve selection.....	66
Defrost cycle initiation.....	66
Defrost inhibition.....	66
Defrost termination.....	67
Cooling operation.....	67
Heating operation.....	67
Emergency heat.....	67
Pressure switch fault detection and lockout.....	68
Third-party trademarks notice.....	68
Wiring diagrams.....	69
Start-up sheet.....	71

About the unit

Read all sections of this manual. Keep this manual and the manual for the matching indoor unit for future reference.

The outdoor units are designed to connect to a matching indoor coil with sweat connect lines. Sweat connect units are factory charged with refrigerant for a nominal sized matching indoor coil and 15 ft of field-supplied lines.

Matching indoor coils can be used with a thermostatic expansion valve (TXV). Refer to the *Tabular Data Sheet* or to the *Technical Guide* for the correct TXV selection.

Certification



Assembled at a facility with an ISO 9001:2015-certified Quality Management System

DS Solutions App

Johnson Controls believes in empowering our customers with unit-specific information at all times. Download the Ducted Systems Solutions Mobile App (DS Solutions App), which is available through the App Store for iOS and Google Play for Android. Users can use the DS Solutions App to scan the QR code located on the rating plate that is unique to each unit and provides information specific to the product. Take advantage of the features available for all units: Nomenclature, Literature (Technical Guide, Installation Manual and Wiring Diagrams), Parts list, Product Registration, Claims Tracking, and more.



iOS



Android

Safety

It is important to understand the safety symbols used in this manual. Read safety information carefully and follow all safety requirements to ensure correct installation.

Understanding safety symbols and instructions



This is a safety alert symbol. When you see this symbol on labels or in manuals, be alert to the potential for personal injury.

Understand and pay particular attention to the signal words **DANGER**, **WARNING**, **CAUTION**, as well as the **NOTICE**, **Important**, and **Note** alerts.

DANGER indicates an **imminently** hazardous situation, which, if not avoided, **will result in death or serious injury**.

WARNING indicates a **potentially** hazardous situation, which, if not avoided, **could result in death or serious injury**.

CAUTION indicates a **potentially** hazardous situation, which, if not avoided **may result in minor or moderate injury**. It is also used to alert against unsafe practices and hazards involving only property damage.

NOTICE indicates information considered important, but not hazard-related, such as messages relating to property damage.

Important indicates information that is essential to complete a task or may result in damage to the device if not followed.

Note indicates something of special interest or importance. Notes can contain any type of information except safety information.

Safety requirements

WARNING

Incorrect installation may create a condition where the operation of the product could cause personal injury or property damage. Incorrect installation, adjustment, alteration, service, or maintenance can cause injury or property damage. Refer to this manual for assistance. For additional information, consult a qualified contractor, installer, or service agency.

CAUTION

This product must be installed in strict compliance with the enclosed installation instructions and any applicable local, state, and national codes including but not limited to building, electrical, and mechanical codes.

CAUTION

R-454B systems operate at higher pressures than R-22 systems. Do not use R-22 or R-410A service equipment or components on R-454B equipment. Service equipment must be rated for R-454B.

A2L refrigerant safety considerations

CAUTION

You must read all of this section before installing this unit.

WARNING

Do not use means to accelerate the defrosting process or to clean, other than those recommended by the manufacturer.

The appliance shall be stored in a room without continuously operating ignition sources (for example, open flames, an operating gas appliance, or an operating electric heater).

Do not pierce or burn.

Be aware that refrigerants may not contain an odor.

WARNING

Auxiliary devices which may be a potential ignition source shall not be installed in the duct work, unless they have been approved by the appliance manufacturer or are suitable for use with the refrigerant being used.

Examples of such potential ignition sources are hot surfaces with a temperature exceeding 700 °C and electric switching devices.

WARNING

Any indoor field-made refrigerant joints shall be tightness tested with no leaks detected. The test method shall have a sensitivity of 5 grams per year of refrigerant or better under a pressure of at least 25% of the maximum allowable pressure.

General

Table 1: Safety considerations

Item number	Safety consideration
1	Any room with an appliance containing more than 3.91 lb in a refrigerating circuit must be constructed such that any refrigerant leak cannot stagnate in a way that would create a fire or explosion hazard.
2	Before beginning work on systems containing flammable refrigerants, safety checks are necessary to ensure that the risk of ignition is minimized. For repair to the refrigerating system, item 3 to item 7 below must be adhered to before conducting work on the system.

Table 1: Safety considerations

Item number	Safety consideration
3	Work must be undertaken under a controlled procedure so as to minimize the risk of a flammable gas or vapor being present while the work is being performed.
4	Instruct all maintenance staff and others working in the local area on the nature of work being carried out. Avoid work in confined spaces.
5	The area must be checked with an appropriate refrigerant detector before and during work to ensure the technician is aware of potentially toxic or flammable atmospheres. Ensure that the leak detection equipment being used is suitable for use with all applicable refrigerants: non-sparking, adequately sealed, or intrinsically safe.
6	If conducting any hot work on the refrigerating equipment or any associated parts, you must have appropriate fire-extinguishing equipment on hand. Have a dry powder or CO ₂ fire extinguisher adjacent to the charging area.
7	If conducting work in relation to the refrigerating system that involves exposing any pipework, do not use any sources of ignition in such a manner that may lead to the risk of fire or explosion. All possible ignition sources, including cigarette smoking, must be kept sufficiently far away from the site of installation, repair, removal, and disposal, during which refrigerant might possibly be released to the surrounding space. Before conducting any work, survey the area around the equipment to ensure that there are no flammable hazards or ignition risks. Display “No Smoking” signs.
8	Ensure the area is in the open or that it is adequately ventilated before opening the system or while conducting any hot work. The ventilation must safely disperse any released refrigerant and preferably expel it externally into the atmosphere.
9	Ensure that the sensor is not obstructed in any way.

Room size requirements

WARNING

If the unit must be installed in a residence with a minimum room area less than what is determined to be the minimum from [Table 2](#), then that room must also not have any continuously operating open flames or other potential ignition sources. A device with a continuous pilot light may be present if that device is provided with an effective flame arrest.

Table 2: Minimum room area

System charge (lb -oz)	Minimum total conditioned room area (ft ²)	Minimum airflow (CFM)
4-0	60	108
4-4	64	115
4-8	67	122
4-12	71	129
5-0	75	135
5-4	79	142
5-8	82	149

Table 2: Minimum room area

System charge (lb -oz)	Minimum total conditioned room area (ft²)	Minimum airflow (CFM)
5-12	86	156
6-0	90	162
6-4	94	169
6-8	97	176
6-12	101	183
7-0	105	189
7-4	109	196
7-8	112	203
7-12	116	210
8-0	120	216
8-4	124	223
8-8	127	230
8-12	131	237
9-0	135	244
9-4	139	250
9-8	142	257
9-12	146	264
10-0	150	271
10-4	154	277
10-8	157	284
10-12	161	291
11-0	165	298
11-4	169	304
11-8	172	311
11-12	176	318
12-0	180	325
12-4	184	331
12-8	187	338
12-12	191	345
13-0	195	352
13-4	199	359
13-8	202	365
13-12	206	372
14-0	210	379
14-4	214	386
14-8	217	392
14-12	221	399
15-0	225	406

Table 2: Minimum room area

System charge (lb -oz)	Minimum total conditioned room area (ft ²)	Minimum airflow (CFM)
15-4	229	413
15-8	232	419
15-12	236	426
16-0	240	433
16-4	244	440
16-8	247	446
16-12	251	453
17-0	255	460
17-4	259	467
17-8	262	474

Note:

- Minimum total conditioned room area refers to the combined area of all air conditioned rooms in the residence.

If the system charge is not listed in [Table 2](#), use the formulas below to calculate the respective values:

- Minimum room area = system charge x 10.742
- Minimum total conditioned area = system charge x 14.458
- Minimum system airflow = system charge x 58.275

Mechanical ventilation

Table 3: Mechanical ventilation

Item number	Safety consideration
1	If installing the unit in a residence below the determined total conditioned area from Room size requirements , then extra mechanical ventilation is required.

Refrigerant equipment checks

Table 4: Refrigerant equipment checks

Item number	Safety consideration
1	Where electrical components are being changed, they must be fit for the purpose and to the correct specification. At all times, the manufacturer's maintenance and service guidelines must be followed. If in doubt, consult the manufacturer's technical department for assistance.
2	<p>Apply the following checks to installations using flammable refrigerants:</p> <ul style="list-style-type: none"> • Ensure the actual refrigerant charge is in accordance with the room size within which the refrigerant-containing parts are installed. • Ensure the ventilation machinery and outlets are operating adequately and are not obstructed. • Ensure marking on the equipment continues to be visible and legible. Correct any markings and signs that are illegible. • Install refrigerating pipe or components in a position where they are unlikely to be exposed to any substance that may corrode refrigerant-containing components, unless the components are constructed of materials that are inherently resistant to being corroded or are suitably protected against being corroded.

Electrical devices checks

Table 5: Electrical devices checks

Item number	Safety consideration
1	Repair and maintenance to electrical components must include initial safety checks and component inspection procedures.
2	If a fault exists that could compromise safety, then do not connect any electrical supply to the circuit until the fault is satisfactorily dealt with. If the fault cannot be corrected immediately but it is necessary to continue operation, use an adequate temporary solution. This must be reported to the owner of the equipment so all parties are advised.
3	<p>Initial safety checks must include:</p> <ul style="list-style-type: none"> • Ensure capacitors are discharged: take care to avoid the possibility of sparking. • Ensure no live electrical components and wiring are exposed while charging, recovering, or purging the system. • Ensure there is continuity of earth bonding.

Detection of refrigerant

Table 6: Detection of refrigerant

Item number	Safety consideration
1	Under no circumstances shall potential sources of ignition be used in the searching for or detection of refrigerant leaks. Do not use a halide torch or any other detector using a naked flame.
2	<p>The following leak detection methods are deemed acceptable for all refrigerant systems.</p> <ul style="list-style-type: none">• Electronic leak detectors may be used to detect refrigerant leaks but, in the case of flammable refrigerants, the sensitivity may not be adequate or may need re-calibration. Calibrate the detection equipment in a refrigerant-free area. Ensure that the detector is not a potential source of ignition and is suitable for the refrigerant used. Set leak detection equipment at a percentage of the LFL of the refrigerant and calibrate to the refrigerant employed. Ensure the appropriate percentage of gas with a maximum of 25% is confirmed.• Leak detection fluids are also suitable for use with most refrigerants but avoid the use of detergents containing chlorine as the chlorine may react with the refrigerant and corrode the copper pipework. Examples of leak detection fluids are bubble method and fluorescent method agents.
3	If a leakage of refrigerant is found that requires brazing, recover all of the refrigerant from the system or isolate the leakage by means of shut-off valves in a part of the system remote from the leak. Remove refrigerant according to the <i>Removal and evacuations</i> section of the outdoor unit's <i>Installation Manual</i> .

Wiring installation

NOTICE

Cap unused wiring connections.

NOTICE

The mitigation control board has a bank of DIP switches. For use with a JHE or JME air handler indoor model, both DIP switches must be in the 0 or off position. For use with all other indoor models, both DIP switches must be in the 1 or on position.

NOTICE

The mitigation control board has a G output and an A2L output. For Y81E, Z8ES, RL18, Y82E, Z8ET, Y82V, Z8VT, Y91E, Z9ES, RG19, Y92E, Z9ET, Y92V, Z9VT, Y9VV, Z9VV, and JMC indoor models, do not use the green G output wire. Instead, use the green/blk A2L and connect it to the G terminal on the indoor equipment.

See [Connecting the wiring](#) for specific information on connecting the wiring for the coil and the chosen indoor and outdoor units.

 **Note:** The 10-pin mitigation harness is included in the loose parts kit.

Figure 1: Mitigation control wiring

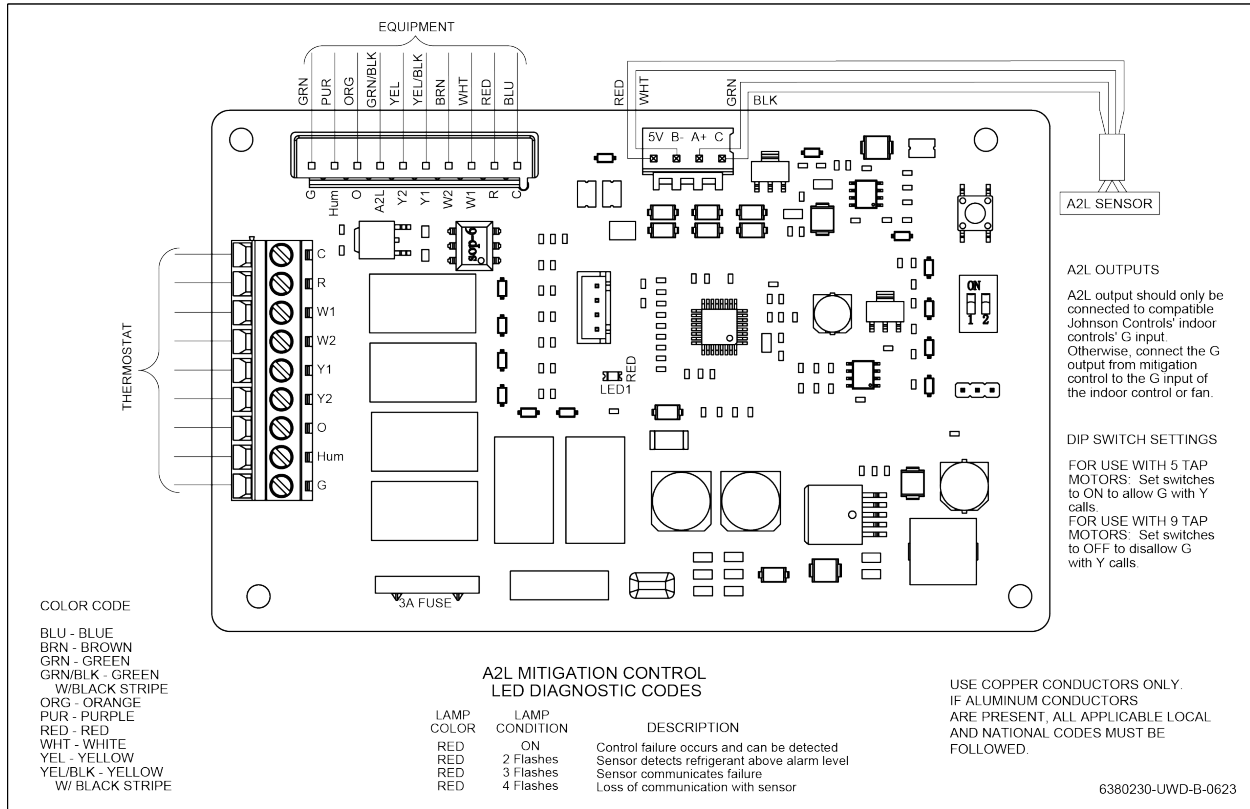
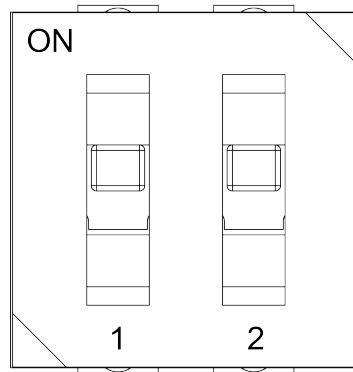

Figure 2 shows the DIP switches on the mitigation control board in the on position.

Figure 2: DIP switches in on position



A2090-001

Field-testing the sensor

1. After wiring and configuring the system, provide a **Y** call for cooling.
2. Simulate an A2L leak by disconnecting the A2L sensor wire from the A2L control board, or shorting the test pins with a screwdriver.

Figure 3: Test pins

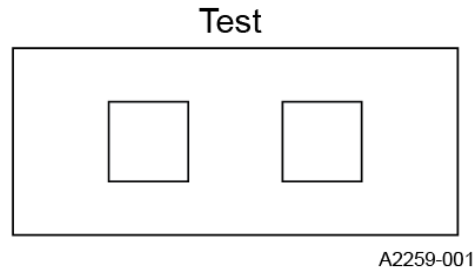

3. After 15 s, verify that the call for the compressor is removed.
4. Verify that the **Y** output pin has no voltage and that the **G** output pin has 24 VAC.
5. Reinstall the sensor or cease shorting the test pins, and verify that the system returns to cooling mode.
6. When the system is in standby mode, repeat the above test for a **W** call for heating.
7. When testing is complete, re-install the front cover on the control box.

Installation overview

Complete all of the stages outlined in [Figure 4](#). You may not need to perform tasks indicated with a dashed outline, depending on the specific installation.

Figure 4: Installation overview

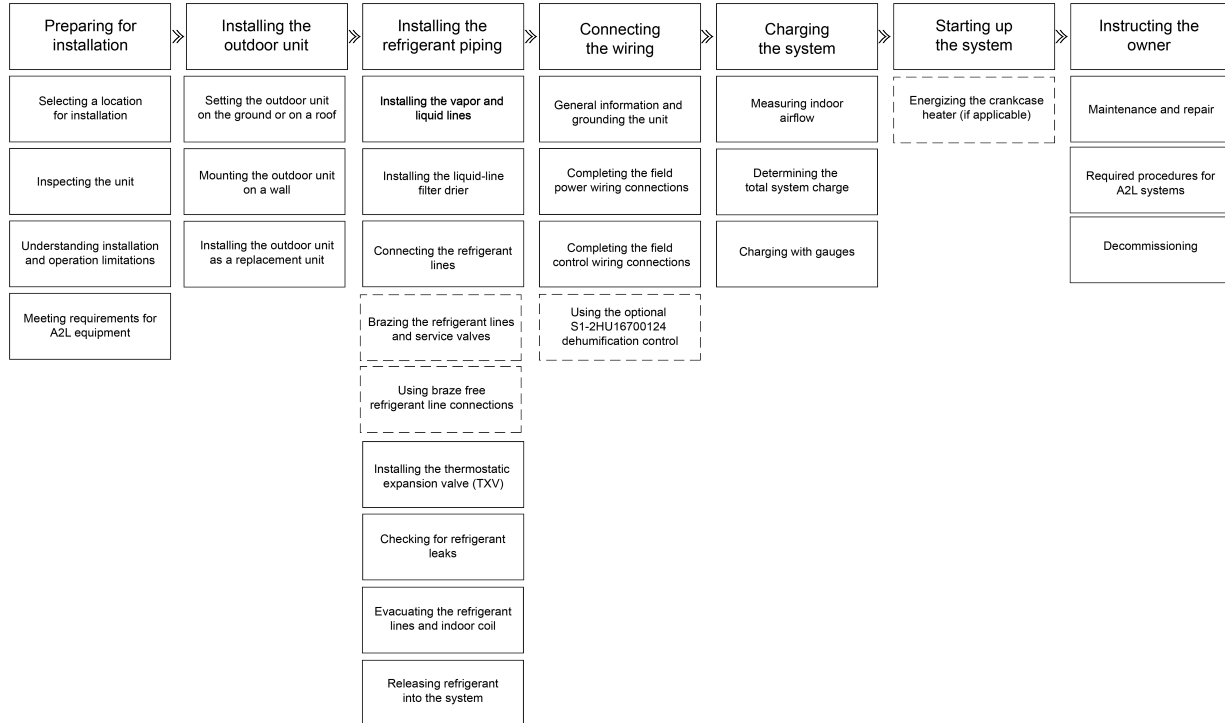

A2020-020

Preparing for installation

WARNING

These units are partial unit air conditioners, complying with the partial unit requirements of this standard, and must only be connected to other units that have been confirmed as complying to corresponding partial unit requirements of this standard, UL 60335-2-40/CSA C22.2 No. 60335-2-40.

Complete the necessary preparation before you begin the installation:

1. Visit the installation site to select a suitable location for the outdoor unit and plan the refrigerant piping system.
2. Inspect the outdoor unit.
3. Make sure that you are aware of the installation and operation limitations.
4. Familiarise yourself with the requirements for installing or servicing R-454B equipment and make sure you have all necessary equipment.

Selecting a location for installation

About this task:

Before starting the installation, you must select a suitable location for the outdoor unit. Observe all limitations and clearance requirements. You can install the outdoor unit on the ground, on a roof, or on a wall.

 **Note:** For more information about selecting a suitable location for the indoor unit, refer to the *Installation Manual* for the indoor unit.

WARNING

The outdoor unit must not be installed in an area where mud or ice could cause personal injury. Condensate will drip from the unit coil during heat and defrost cycles and this condensate will freeze when the temperature of the outdoor air is below 32°F.

NOTICE

For multiple unit installations, units must be spaced a minimum of 24 in. (61 cm) apart, coil face to coil face.

► **Important:** To prevent damage to the unit, do not install the unit in the following locations:

- Where there is machine oil
- Coastal regions where the equipment is prone to atmospheric corrosion
- Near hot springs where the equipment is prone to sulfide gas corrosion
- In proximity to high-frequency or wireless equipment

- Select a location for the outdoor unit that meets the following general requirements for installation:
 - Is away from bedroom windows or other room windows where the sound of the unit operation might be objectionable.
 - Provides adequate structural support for the unit.
 - Allows sufficient clearance for air entrance to the outdoor coil, air discharge, and service access.
 - Isolate the unit from rain gutters to avoid any possible wash out of the foundation.
 - Allows you to elevate the unit sufficiently to prevent any blockage of the air entrances by snow in areas where snow may accumulate. Check the local weather bureau for the expected snow accumulation in your area.
 - If the unit is installed on a hot sun-exposed roof or a paved ground area that is seasonally hot, the unit must be raised sufficiently above the roof or ground to avoid taking the accumulated layer of hot air into the outdoor unit.
 - If the system is being installed during seasonally cold weather of 55°F or below, the preferred method is to weigh in the charge. For charging or checking the system charge at 55°F or below, see the *Heating charging charts*. An optional cold weather charging accessory kit is available to prevent the outdoor unit from taking in cold air below 55°F. The kit part number can be found in the list of accessory kits at www.simplygettingthejobdone.com.
- Select a location for the outdoor unit that meets any requirements that are specific to the type of installation as outlined in [Table 7](#).

Table 7: Additional location requirements for each type of installation

Type of installation	Additional location requirements
Ground installation	<ul style="list-style-type: none"> • The location of the outdoor unit allows installation at ground level on a solid base that does not shift or settle, causing strain on the refrigerant lines and possible leaks. • The location of the outdoor unit allows for the condensate to drain directly on the ground in a safe area where public walkways will not be impacted.
Roof installation	<ul style="list-style-type: none"> • The structure is capable of supporting the total weight of the unit, including a base, lintels, and rails. You must use a base, lintels, and rails to minimize the transmission of sound or vibration to the structure. • The location of the outdoor unit allows sufficient space for the base. The base must not come in contact with the foundation or side of the structure because sound may transmit to the residence.
Wall-mounted installation	<ul style="list-style-type: none"> • Mounting the outdoor unit does not cause a loss of structural integrity. • The location of the outdoor unit ensures that there is minimal transmission of sound and vibration into the living space. • The outdoor unit can be accessed safely when mounted, for example, for servicing. • The location of the outdoor unit allows you provide adequate support for the base pan.

Inspecting the unit

1. Remove the shipping carton and inspect the unit immediately after receiving it for possible damage during transit.
2. If damage is evident, do the following:
 - a. Note the extent of any damage on the carrier's receipt.
 - b. Make a separate written request for the carrier's agent to inspect the unit.
 - c. Contact the local distributor for more information.

Understanding installation and operation limitations

Install the unit in accordance with all national, state, and local safety codes, and the following requirements:

- Observe the limitations for the indoor unit, coil, and appropriate accessories.
- Do not install the outdoor unit with any ductwork in the air stream. The outdoor fan is a propeller fan and is not designed to operate against any additional external static pressure.
- Rotary compressor - If you are selecting a unit with a rotary compressor, the maximum equivalent interconnecting line length is 100 ft.
- Observe the maximum and minimum conditions for operation to ensure that the system gives maximum performance and requires minimum service. See [Table 8](#).

Table 8: Maximum and minimum operating limit conditions

Air temperature	Outdoor coil °F (°C)		Indoor coil °F (°C)	
	DB cool	DB heat	WB cool	DB heat
Minimum	55 (13)	0 (-18)	57 (14)	50 (10)
Maximum	125 (52)	75 (24)	72 (22)	80 (27)

- ⓘ **Note:** Operation below the minimum temperature is permissible for a short period of time, during morning warm-up.
- **Important:** Do not operate the unit in cooling mode at outdoor temperatures below 50°F without an approved low ambient operation accessory kit installed.
- **Important:** The maximum allowable line length for this product is 80 ft. Consult the *Piping Application Guide (P/N 247077)* for installations over the maximum allowable line length. Installation of an accessory crankcase heater is required if not factory-installed for installations over the maximum allowable line length.

Meeting requirements for A2L equipment

Make sure that you have all necessary equipment before you begin the installation. You must adhere to the following requirements when installing or servicing R-454B equipment:

- Gauge sets, hoses, refrigerant containers, and the recovery system must be designed to handle the POE type oils and the higher pressures of R-454B.
- Manifold sets should be high side and low side with low side retard.
- All hoses must have a 700 psig service pressure rating.
- Electronic leak detectors can be used for detecting refrigerant leaks. For flammable refrigerants, check the sensitivity and potentially recalibrate the detector.
- Leak detection fluids are also suitable for use with most refrigerants. Avoid using detergents containing chlorine, as they can react with refrigerants and corrode copper pipework. Examples of leak detection methods include the bubble method and fluorescent agents.

- Recovery equipment (including refrigerant recovery containers) must be specifically designed to handle R-454B.
- Only use a TXV that is specifically designed for R-454B refrigerant.
- If an indirect refrigerating circuit is used, inspect the secondary circuit for refrigerant presence.
- Maintain visible and legible markings on the equipment. Illegible markings or signs should be corrected.
- Install refrigerant pipes and components in locations where they are unlikely to be exposed to corrosive substances, unless the components are made from corrosion-resistant materials or adequately protected against corrosion.

Installing the outdoor unit

There are three installation options for the outdoor unit: ground installation, roof installation, and wall-mounted installation. You must follow all requirements for the specific type of installation. See [Selecting a location for installation](#) for location requirements for ground, roof, and wall-mounted installation.

If you are installing the outdoor unit as a replacement for an existing unit, follow the procedure outlined in [Installing the outdoor unit as a replacement unit](#).

Setting the outdoor unit on the ground or on a roof

Before you begin:

Make sure that the location you have selected for the outdoor unit is suitable. See [Selecting a location for installation](#).

About this task:

For ground installation, you must use a strong, solid base, made of concrete or a similar material. For roof installation, you must use a base, lintels, and rails to minimize the transmission of sound or vibration to the structure. If site conditions require, elevate the unit above the base, for example, using riser legs, a stand, or snow legs.

NOTICE

Heat pumps defrost periodically resulting in water drainage. Do not locate the unit where water drainage may freeze and create a hazardous condition, such as sidewalks and steps.

1. Position the base in the pre-determined location, see [Selecting a location for installation](#).
2. Ensure that compressor tie-down bolts remain tightened.
3. Install the unit in as level a position as possible while maintaining the clearances shown in [Figure 5](#) and [Figure 6](#).
4. Fasten the outdoor unit tightly to prevent noise.

Figure 5: Typical installation clearances

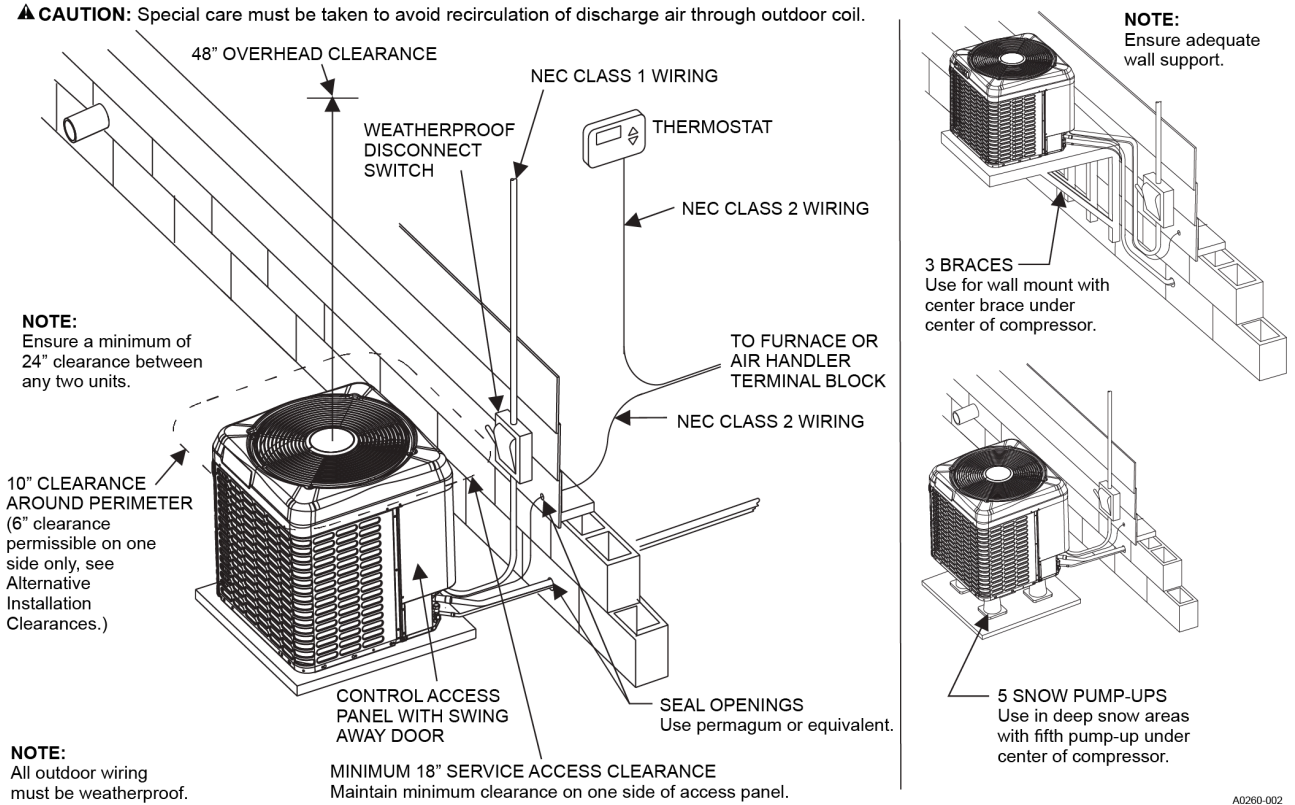
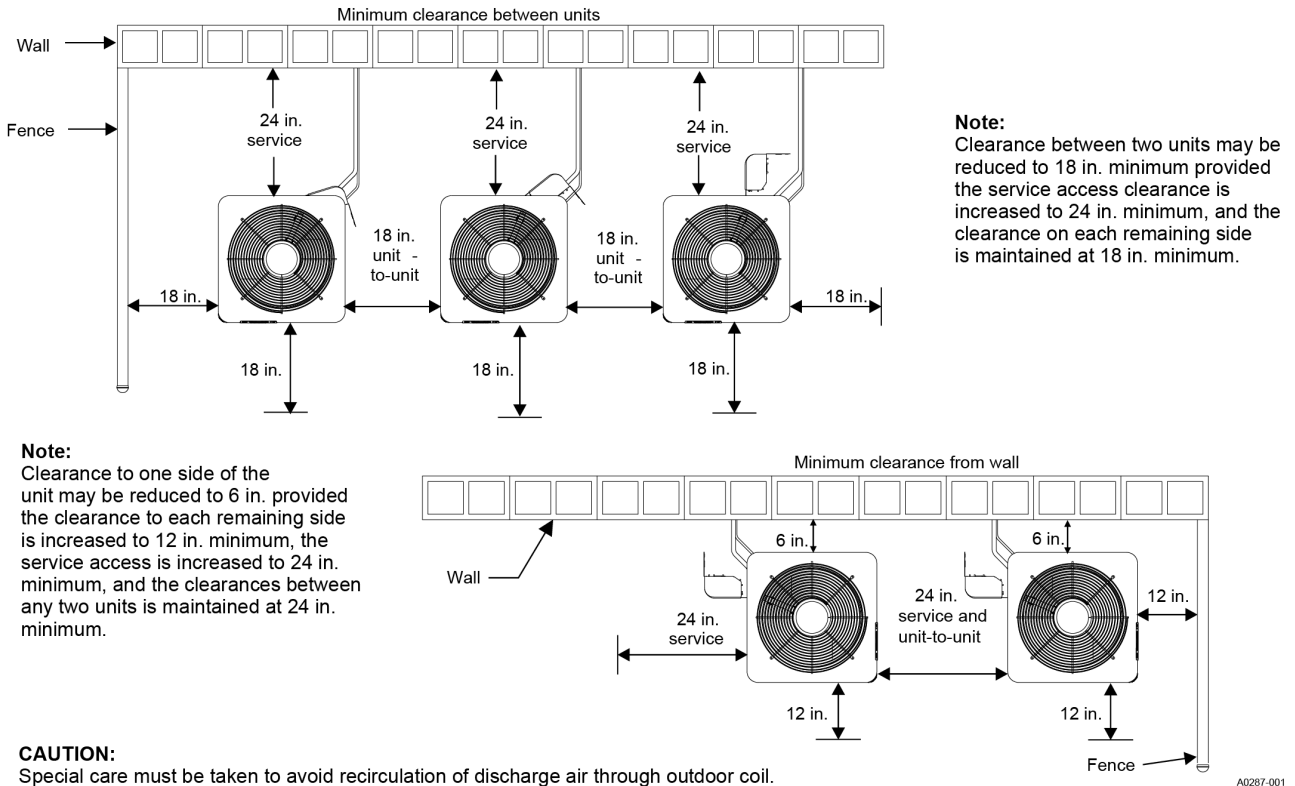

Figure 6: Alternative installation clearances



Mounting the outdoor unit on a wall

Before you begin:

On occasion, site conditions may require direct wall mounted brackets to be used to locate and support the outdoor unit. In these applications, address unit base pan support, structural integrity, safe access, and serviceability, as well as the possible sound and vibration transmission into the structure.

About this task:

When site conditions require you to mount the outdoor unit on a wall, you must use two direct wall mount brackets to support the outdoor unit. The wall mount brackets are field supplied. It is important to be aware that wall mounting is best served by a correctly engineered solution.

1. Make sure that the location you have selected for the outdoor unit is suitable. See [Selecting a location for installation](#).
2. Use two wall mount brackets to mount the outdoor unit on the wall.

Installing the outdoor unit as a replacement unit

About this task:

When installing this unit as a replacement for an existing R-410A unit, you must replace the outdoor unit, indoor coil, and metering device. Complete all of the steps outlined to ensure correct system operation and performance. Replace the refrigeration piping where possible.

WARNING

Never install a suction-line filter drier in the liquid line of an R-454B system. Failure to follow this warning can cause a fire, injury, or death.

NOTICE

Never leave a suction-line drier in the system for longer than 50 h of run time.

1. Remove the existing outdoor unit.
2. Make sure that the location of the outdoor unit you are replacing is suitable for installing the new outdoor unit. See [Selecting a location for installation](#).
3. Replace the indoor coil with an approved R-454B coil or outdoor unit combination with the appropriate metering device.
4. Install the outdoor unit. See [Setting the outdoor unit on the ground or on a roof](#) or [Mounting the outdoor unit on a wall](#).
5. Replace the refrigeration piping when replacing an R-22, R-410A, or other refrigerant unit with an R454B unit to reduce cross-contamination of oils and refrigerants. See [Table 9](#).

Table 9: Replacing refrigerant piping

Installation condition	Approach
You are replacing an outdoor unit that uses R-22, R-410A, or other refrigerant with an outdoor unit that uses R-454B refrigerant	Replace the refrigerant piping to reduce cross-contamination of oils and refrigerants. See Installing the refrigerant piping . If replacing the refrigerant piping is not practical, take the following precautions: <ol style="list-style-type: none">1. Inspect the refrigeration piping for kinks, sharp bends or other restrictions, and for corrosion.2. Determine if there are any low spots which might be serving as oil traps.3. Flush the refrigeration piping with a commercially available flush kit to remove as much of the existing oil and contaminants as possible.4. Install a suction line filter-drier to trap any remaining contaminants, and remove after 50 h of operation.
You are replacing the outdoor unit because of a compressor burnout	Replace the refrigerant piping or, at a minimum, thoroughly flush the refrigerant piping with a commercially available flush kit.

6. If the outdoor unit is being replaced due to a compressor burnout, then the installation of a 100% activated alumina suction-line filter-drier in the suction-line is required, in addition to the field-installed biflow liquid-line drier. See [Table 9](#). Take the following steps:
 - Operate the system for 10 h. Monitor the suction drier pressure drop.
 - If the pressure drop exceeds 3 psig, replace both the suction-line and liquid-line driers.
 - After a total of 10 h runtime where the suction-line pressure drop has not exceeded 3 psig, replace the liquid-line drier, and remove the suction-line drier.

Installing the refrigerant piping

To install the refrigerant piping correctly, you must do the following:

1. Install the vapor line and liquid line.
2. Install a liquid-line filter drier on the liquid line.
3. Braze the refrigerant lines and service valves.
4. Install the thermostatic expansion valve (TXV).
5. Check the refrigerant system for leaks.
6. Evacuate the system.
7. Release refrigerant into the system.

Installing the vapor and liquid lines

About this task:

Connect the outdoor unit to the indoor coil using field-supplied refrigerant grade (ACR) copper tubing that is internally clean and dry. Only install the unit with the tubing sizes for approved system combinations as specified in the *Tabular data sheet*. The charge given is applicable for total tubing lengths up to 15 ft (4.6 m). Refer to the *Piping Application Guide (P/N 247077)* for installing tubing of longer lengths and elevation differences.

Rotary compressor - If you are selecting a unit with a rotary compressor, the maximum equivalent interconnecting line length is 100 ft.

NOTICE

Using a larger than specified line size could result in oil return problems. Using too small a line results in loss of capacity and other problems caused by insufficient refrigerant flow. Slope horizontal vapor lines at least 1 in. (2.5 cm) every 20 ft (6.1 m) toward the outdoor unit to facilitate sufficient oil return. If more than the 80 ft line length is necessary, facilitate sufficient refrigerant velocity with adjusted line diameter in accordance with the *Piping Application Guide (P/N 247077)*.

CAUTION

This system uses R-454B refrigerant which operates at higher pressures than R-22. No other refrigerant may be used in this system. Gauge sets, hoses, refrigerant containers, and the recovery system must be designed to handle R-454B. If you are unsure, consult the equipment manufacturer.

WARNING

Never install a suction-line filter-drier in the liquid line of an R-454B system. Failure to follow this warning can cause a fire, injury or death.

- Install the lines with as few bends as possible. Take care not to damage the couplings or kink the tubing. Use clean hard drawn copper tubing where no appreciable amount of bending around obstruction is necessary. If soft copper must be used, take care to avoid sharp bends which may cause a restriction.

- Install the lines so that they do not obstruct service access to the coil, air handling system, or filter.
- Take care to isolate the refrigerant lines to minimize noise transmission from the equipment to the structure.
- Insulate the vapor line with a minimum of 1/2 in. foam rubber insulation such as Armaflex or an equivalent. Liquid lines exposed to direct sunlight, high temperatures, or excessive humidity must also be insulated.
- Tape and suspend the refrigerant lines as shown. Do not allow tube metal-to-metal contact. See [Figure 7](#).
- Use PVC piping as a conduit for all underground installations as shown in [Figure 8](#). Keep buried lines as short as possible to minimize the build up of liquid refrigerant in the vapor line during long periods of shutdown.

Figure 7: Installation of vapor line

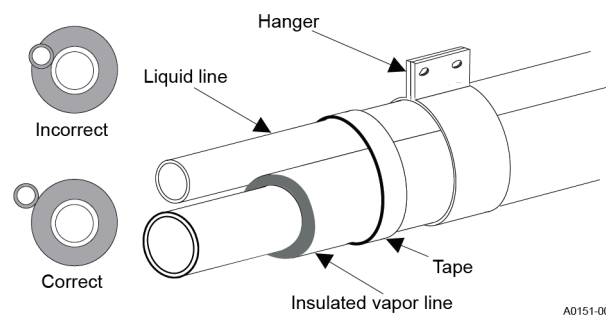

- Pack fiberglass insulation and a sealing material such as permagum around refrigerant lines where they penetrate a wall to reduce vibration and to retain some flexibility.
- For systems with total line length exceeding 80 ft (22.86 m), refer to *Piping Application Guide* (P/N 247077) for the following specifications:
 - Vapor and liquid line sizing
 - Calibration of liquid line pressure loss or gain
 - Determination of vapor line velocity
 - Elevation limitations
 - TXV connections
 - System charging
 - Traps
 - Crankcase heater

Figure 8: Underground installation

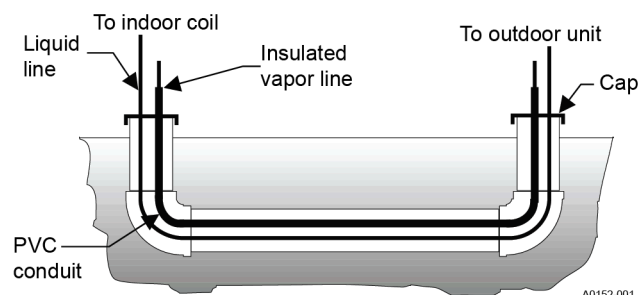

Installing the liquid line filter-drier

About this task:

The liquid line filter-drier is packaged and shipped along with the outdoor unit.

CAUTION

Filter-drier is required to be installed in liquid line. The recommended location is at the indoor coil before the refrigerant metering device. It can be installed at the outdoor unit if required.

CAUTION

Using a granular type drier may result in damage to the equipment.

CAUTION

The liquid line filter-drier must be wrapped in a wet rag while brazing.

NOTICE

All replacements for the liquid line filter-drier must be bi-flow and be an approved replacement from Source 1.

1. Find a suitable location on the liquid line to install the filter-drier. The preferred location is inside at the indoor coil before the metering device. If this is not possible, outside next to the liquid service valve is acceptable.
2. Install the liquid-line filter drier in accordance with the installation instructions for the liquid-line filter drier.

Connecting the refrigerant lines

Depending on the indoor coil model and application, there are two methods of connecting the refrigerant lines:

1. Brazing the connections
2. Using non-braze connections

Some coil models have straight piping connections ready for use with braze-free connectors. You can also use straight piping connections for brazing, but you need to expand the pipe in the field using a swage tool. Alternatively, use a sweat coupling.

Brazing the refrigerant lines and service valves

About this task:

It is important to take the necessary precautions for brazing the refrigerant lines and service valves. All outdoor unit and indoor coil connections are copper-to-copper and you must braze them with a phosphorous-copper alloy material such as Silfos-5 or equivalent. **Do not use soft solder.** The outdoor units have reusable service valves on both the liquid and vapor connections. The total system refrigerant charge is retained within the outdoor unit during shipping and installation. The reusable service valves are provided to evacuate and charge as outlined in this manual. You can avoid serious service problems by taking adequate precautions to ensure an internally clean and dry system.

⚠ CAUTION

Dry nitrogen must always be supplied through the tubing while it is being brazed because the temperature required is high enough to cause oxidation of the copper unless an inert atmosphere is provided. The flow of dry nitrogen must continue until the joint cools. Always use a pressure regulator and safety valve to ensure that only low pressure dry nitrogen is introduced into the tubing. Only a small flow is necessary to displace air and prevent oxidation.

Figure 9: Heat protection

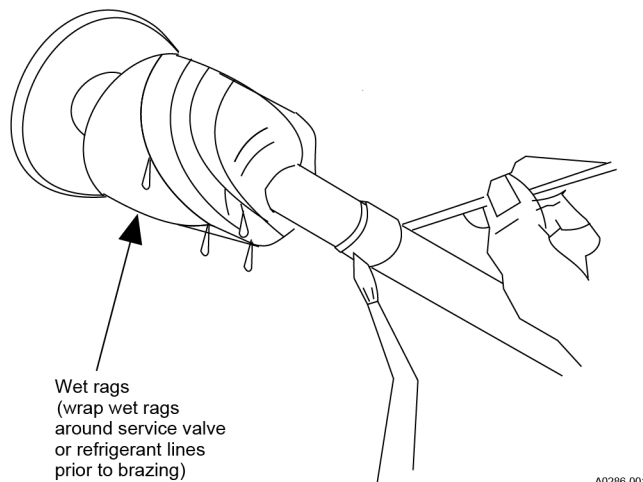

⚠ CAUTION

Do not install any coil in a furnace which is to be operated during the heating season without attaching the refrigerant lines to the coil. The coil is under pressure which must be released to prevent excessive pressure build-up and possible coil damage.

 **CAUTION**

Do not connect manifold gauges unless trouble is suspected. Approximately 3/4 oz of refrigerant is lost each time a standard manifold gauge is connected.

 **WARNING**

Never attempt to repair any brazed connections while the system is under pressure. Personal injury could result.

Take the following precautions when brazing the service valve:

- Wrap a wet rag around the service valve to prevent heat damage as shown in [Figure 9](#).
- Protect items such as all painted surfaces, insulation, and the plastic base during brazing.
- After brazing, cool the joint with a wet rag.

WARNING

This is not a backseating valve. The service access port has a valve core. The opening or closing valve does not close service access port. If the valve stem is backed out past the chamfered retaining wall, the O-ring can be damaged causing leakage or system pressure could force the valve stem out of the valve body possibly causing personal injury.

Once you have considered the precautions, proceed with brazing the refrigerant lines and service valves:

1. Remove the cap and Schrader core from both the liquid and vapor service valve service ports at the outdoor unit.
2. Connect low pressure nitrogen to the liquid line service port.
3. Braze the liquid line to the liquid valve at the outdoor unit. Be sure to wrap the valve body with a wet rag. Allow the nitrogen to continue flowing.
4. Carefully remove the plugs from the indoor liquid and vapor connections at the indoor coil.
5. Braze the liquid line to the indoor coil liquid connection. Nitrogen should be flowing through the indoor coil.
6. Slide the grommet away from the vapor connection at the indoor coil. Braze the vapor line to the indoor coil vapor connection. After the connection has cooled, slide the grommet back into original position.
7. Protect the vapor valve with a wet rag and braze the vapor line connection to the outdoor unit. The nitrogen flow should be exiting the system from the vapor service port connection. After this connection has cooled, remove the nitrogen source from the liquid fitting service port.
8. Replace the Schrader core in the liquid and vapor valves.

Using braze free refrigerant line connections

About this task:

Use the following steps to fit braze-free refrigerant line connections. For brazed connections, see [Brazing the refrigerant lines and service valves](#).

► **Important:** Prepare the valve and line connections per the braze-free connection part's *Installation Instructions*.

1. Fit a braze-free connection onto the liquid valve on the outdoor unit.
2. Connect the liquid line to the outdoor unit liquid valve braze-free connection.
3. Fit a braze-free connection to the outdoor unit vapor valve. Connect the vapor valve line to the outdoor vapor valve braze-free connection.
4. Prepare and connect indoor coil liquid and vapor line connections following the indoor coil installation instructions. If any brazing will take place, dry nitrogen must be flowing to prevent oxidation.
5. Carefully remove the plugs from the liquid and vapor connections at the indoor coil.

6. Connect the liquid line to the liquid braze-free connection on the indoor coil.
7. Connect the vapor line to the indoor coil's vapor valve braze-free connection.
8. Install the liquid line and vapor line grommets on the indoor coil.

Installing the thermostatic expansion valve (TXV)

This is a basic overview of the procedure, for detailed instructions, refer to the *Installation Manual* accompanying the TXV kit and the indoor coil. Install the TXV kit as follows:

► **Important:** Refer to the *Technical Guide* for the unit to determine the correct TXV kit to use on this product.

1. Relieve the holding charge by depressing the Schrader core on the suction manifold stub out.
2. After the holding charge is completely discharged, loosen and remove the Schrader core.
3. Place a backup wrench on the distributor, then loosen and remove the brass distributor nut. Retain the brass nut for use on the liquid line. Keep the PTFE washer in place and discard the clear disk.
4. Install the TXV to the distributor assembly with the supplied fittings. Ensure that the PTFE washer is seated in the distributor. Hand tighten and turn an additional quarter turn to seal. Do not over-tighten fittings. See [Figure 10](#).

CAUTION

Do not over-torque. Do not use slip joint pliers. This distorts the aluminum distributor and the brass fitting, potentially causing leaks.

5. Slide the nut removed in Step 3 over the supplied liquid line. Place the supplied PTFE washer from the TXV kit on the TXV, and install liquid line to the top of the TXV. Adjust assembly so liquid line aligns with hole in access panel. Hand tighten the liquid line, and apply an additional quarter turn to seal.

WARNING

Schrader valve core must not be installed with TXV installation. Poor system performance or system failure could result.

Figure 10: TXV installation

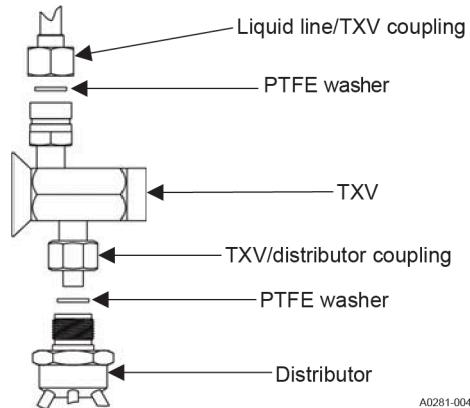

6. Install the TXV equalizer line onto the vapor line by hand tightening the 1/4 in. SAE coupling nut to the equalizer fitting, and applying an additional third turn to seal. See [Figure 11](#).

Figure 11: TXV bulb and equalizer line installations

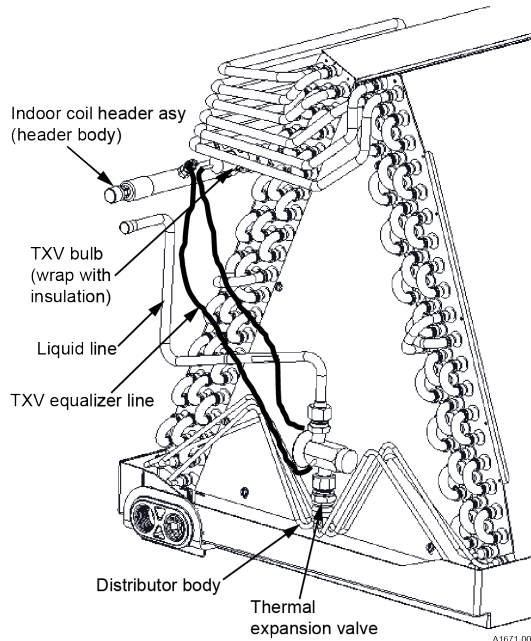

CAUTION

In all cases, mount the TXV bulb after vapor line is brazed and has had sufficient time to cool. Failure to use suction line grommet may result in premature TXV failure.

7. If the indoor coil is an **A** coil, skip to Step 8. If not, pass the TXV temperature sensing bulb through the suction line split grommet in the access panel.

8. Install the TXV bulb to the vapor line using the bulb clamps furnished with the TXV assembly. Ensure the bulb is making maximum contact. See [Figure 11](#) and [Figure 12](#).
 - a. If possible, install the temperature bulb on a horizontal run of the vapor line. Ensure that the bulb is installed at a 10 o'clock or 2 o'clock position. See [Figure 12](#).
 - b. If bulb installation is made on a vertical run, ensure that the bulb is a minimum of 8 in. (20.3 cm) away from the elbow coming out of the coil. Position the bulb with the tail of the bulb at the top, so that the bulb acts as a reservoir.
 - c. Insulate the bulb using thermal insulation provided to protect it from the effect of the surrounding ambient temperature. Cover completely to insulate.

Figure 12: Correct bulb location

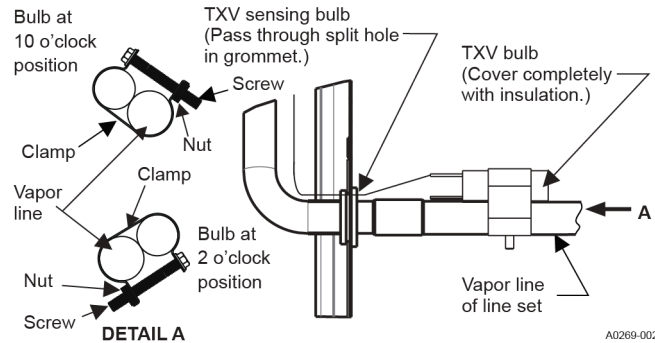

What to do next:

After the refrigerant piping is installed, leak test the system.

Checking for refrigerant leaks

About this task:

NOTICE

Pressurize the refrigerant piping and the indoor coil to 250 psig with dry nitrogen and leak test with a bubble type leak detector. Then release the nitrogen charge.

Do not use the system refrigerant in the outdoor unit to purge or leak test.

1. Pressurize the refrigerant piping and the indoor coil to 250 psig with dry nitrogen.
2. Leak test all refrigerant piping connections including the service port flare caps to be sure they are leak tight. Do not over-tighten the refrigerant piping connections: tighten between 40 in-lb and 60 in-lb maximum.
3. Release the nitrogen charge.
4. If refrigerant leaks are present, repair the leaks and repeat Step 1 to Step 4 as needed until the testing indicates that no refrigerant leaks are present.

Evacuating the refrigerant lines and indoor coil

Evacuate the system to 500 microns or less. If a leak is suspected, leak test with dry nitrogen to locate the leak. Repair the leak and test again.

About this task:

To verify that the system has no leaks, do the following steps:

1. Close the valve to the vacuum pump suction to isolate the pump and hold the system under vacuum.
2. Watch the micron gauge for a few minutes.
 - a. If the micron gauge indicates a steady and continuous rise, it is an indication of a leak.
 - b. If the gauge shows a rise, then levels off after a few minutes and remains fairly constant, it is an indication the system is leak free but still contains moisture and may require further evacuation if the reading is above 500 microns.

Releasing refrigerant into the system

Before you begin:

Make sure that you have checked the refrigerant system for leaks and evacuated the refrigerant lines and indoor coil before releasing the refrigerant charge into the system. See [Checking for refrigerant leaks](#) and [Evacuating the refrigerant lines and indoor coil](#).

About this task:

To release the refrigerant charge into the system, follow these steps:

1. Open the liquid line service valve first.
2. When the system pressures have equalized, open the vapor line service valve by removing the valve caps and turning the valve counterclockwise using a hex-head wrench.
3. If the service valve is a ball valve, use an adjustable end wrench to turn the valve stem one-quarter turn counterclockwise to open. Do not overturn or the valve stem may break or become damaged. See [Brazing the refrigerant lines and service valves](#).
4. Replace the service valve cap finger tight, then tighten an additional 1/12 turn (1/2 hex flat). Replace the cap to prevent leaks.
5. See [Charging the system](#) for checking and recording system charge.

Connecting the wiring

To connect the wiring correctly, you must do the following:

1. Observe the general information and grounding information.
2. Install the field connections power wiring.
3. Install the field connections control wiring.
4. Control the dehumidification of the unit.
5. Configure the typical indoor cubic feet per minute (CFM) settings.

See [Wiring diagrams](#) for the outdoor unit wiring diagrams.

General information and grounding the unit

Before you begin:

Before you connect the wiring for the outdoor unit, note the information below.

About this task:

NOTICE

Install flexible electrical wiring to use the swing away function of the control box. Rigid type electrical connections require the wiring to be disconnected to swing the control box open.

CAUTION

All field wiring must use copper conductors only and be in accordance with local, national, fire, safety and electrical codes. This unit must be grounded with a separate ground wire in accordance with the above codes.

- The control box cover is held in place with three screws, one screw in each lower corner and one screw at the top center post. The control box can swing open by removing the screw from the center of each side of the control box and allowing the control box to lower an inch into a pivotal position.
- The control box can then swing open from the left by rotating on the right side pivots for easy service of refrigeration components. If no wiring is in or routed through the control box, it can be removed from the unit by lifting slightly, tilting the top hinge out, and lifting the bottom hinge out. During the installation, route the low voltage wiring for the thermostat along the unit high voltage wiring to help facilitate the swing away feature of the control box. See [Figure 13](#).
- Check the electrical supply to be sure that it meets the values specified on the unit nameplate and wiring label.
- Power wiring, control (low voltage) wiring, disconnect switches and over current protection must be supplied by the installer. Wire size must be sized per NEC requirements.
- The complete connection diagram and schematic wiring label is located on the inside surface of the unit service access panel.

Figure 13: Outdoor unit swing away control box

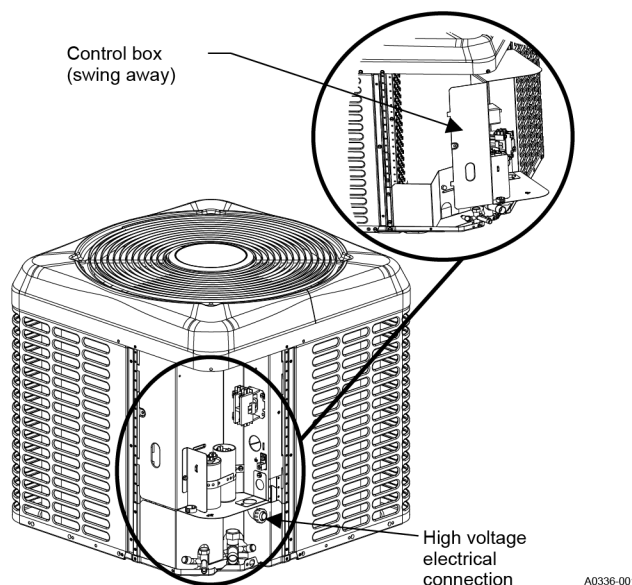

Completing the field power wiring connections

1. Install the correct size weatherproof disconnect switch outdoors and within sight of the unit.
2. Remove the screws at the top and sides of the corner cover.
3. Slide the control box cover down and remove from unit.
4. Run power wiring from the disconnect switch to the unit.
5. Route wires from disconnect through power wiring exit provided and into the unit control box correct location as shown in [Figure 14](#).
6. Install the correct size time-delay fuses or circuit breaker, and make the power supply connections.

Completing the field control wiring connections

1. Route low voltage wiring into bottom of control box correct location as shown in [Figure 14](#). Connect low voltage wiring to the appropriate connections. See [Figure 18](#).
2. The complete connection diagram and schematic wiring label is located on the inside surface of the unit service access panel.
3. Replace the control box cover removed in Step 2 of [Completing the field power wiring connections](#).
4. All field wiring to be in accordance with national electrical codes (NEC) and local-city codes.

NOTICE

Use a Start Assist Kit for long refrigerant piping applications or in areas of known low voltage problems.

5. Mount the thermostat about 5 ft above the floor, where it is exposed to normal room air circulation. Do not place it on an outside wall or where it is exposed to the radiant effect from exposed glass or appliances, drafts from outside doors or supply air grilles.

- Route the 24 V control wiring (NEC Class 2) from the outdoor unit to the indoor unit and thermostat.

NOTICE

To eliminate erratic operation, seal the hole in the wall at the thermostat with permagum or equivalent to prevent air drafts affecting the operation of in the thermostat.

NOTICE

Check that cabling will not be subject to wear, corrosion, excessive pressure, vibration, sharp edges, or any other adverse environmental effects. Take into account the effects of aging or continual vibration from sources such as compressors or fans.

Figure 14: Outdoor unit control box (208/230 V single-phase 18, 24, 36, 48, and 60 models only)

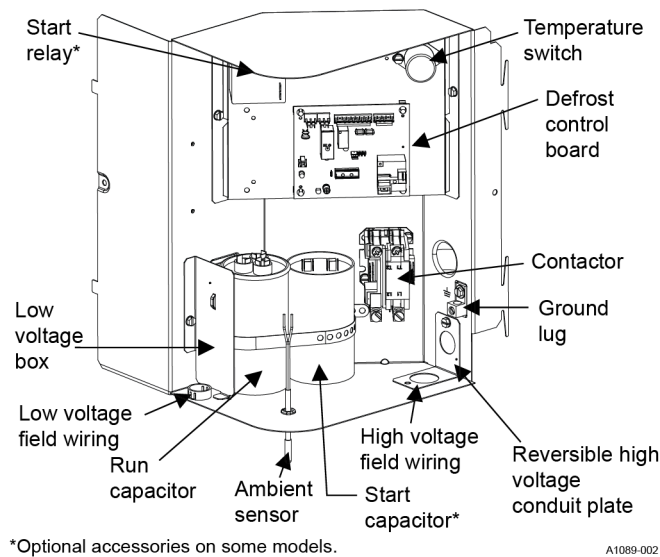

Control wiring diagrams

Figure 15: Standard ECM air handler and standard single-stage heat pump - conventional wiring

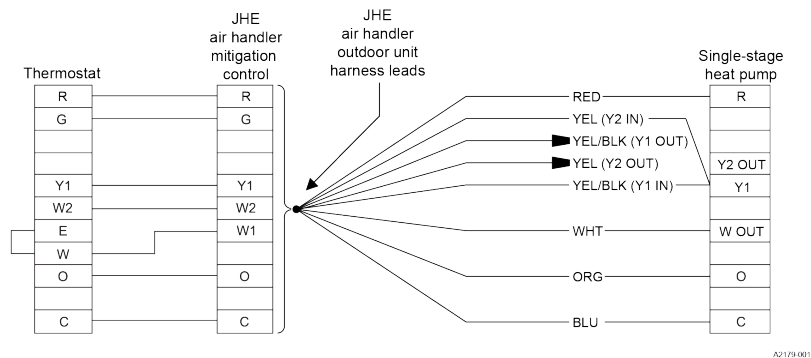

A2179-001

NOTICE

The mitigation control board has a bank of dip-switches. For use with indoor model JHE air handler, both switches must be in the 0 or OFF position.

For single-stage applications, JHE outdoor unit harness connections Y1 IN and Y2 IN must be bonded together as shown.

Figure 16: Standard ECM modular air handler and standard single-stage heat pump conventional wiring

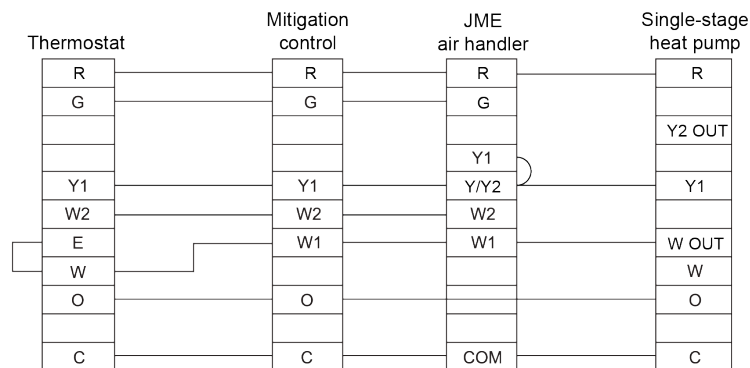

A2178-001

NOTICE

The mitigation control board has a bank of dip-switches. For use with indoor model JME air handler, both switches must be in the 0 or OFF position.

For single-stage applications, JME Y1 and Y/Y2 must be bonded together as shown.

The following notices apply to [Figure 17](#) and [Figure 18](#).

NOTICE

Do not bond any of the outdoor unit W wires together.

NOTICE

*W2 input only available on two-stage gas heat models.

NOTICE

Fossil fuel operation **must** be controlled by room thermostat.

NOTICE

Gas furnace heat pump jumper must be set to YES.

NOTICE

The mitigation control board has a bank of DIP switches. For use with indoor model JHE or JME air handlers, both switches must be in the 0 or OFF position. For all other indoor models, both switches must be in the 1 or ON position.

NOTICE

JHE air handler outdoor unit harness leads have a Y2 IN/OUT disconnect that may need to be separated during wiring connections. Refer to the JHE air handler *Installation Manual* for full details.

Figure 17: Standard ECM air handler and standard multi-stage heat pump - conventional wiring

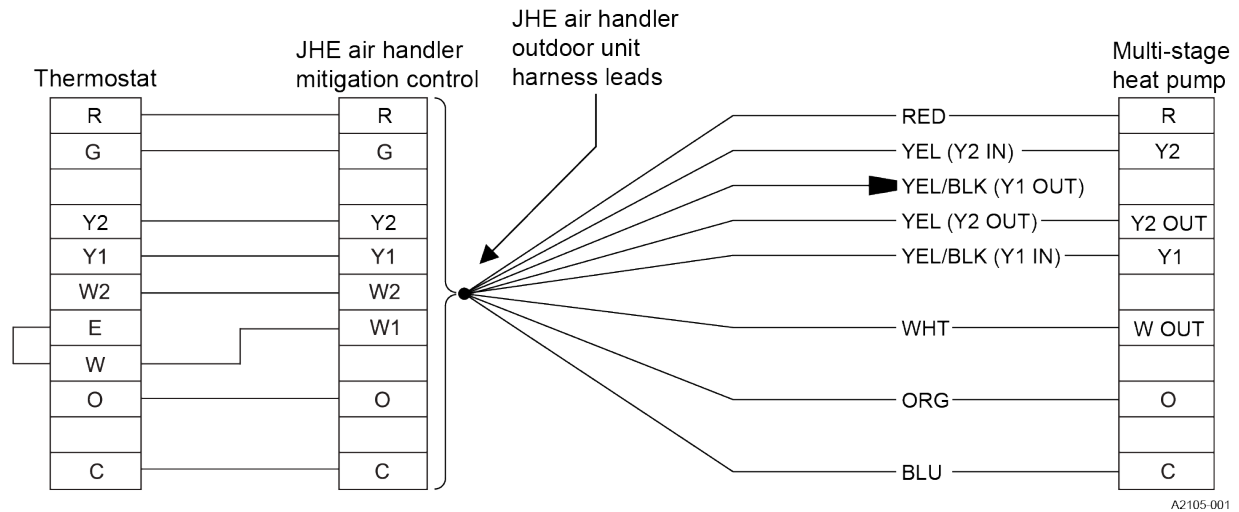

A2105-001

Figure 18: Standard ECM modular air handler and standard multi-stage heat pump - conventional wiring

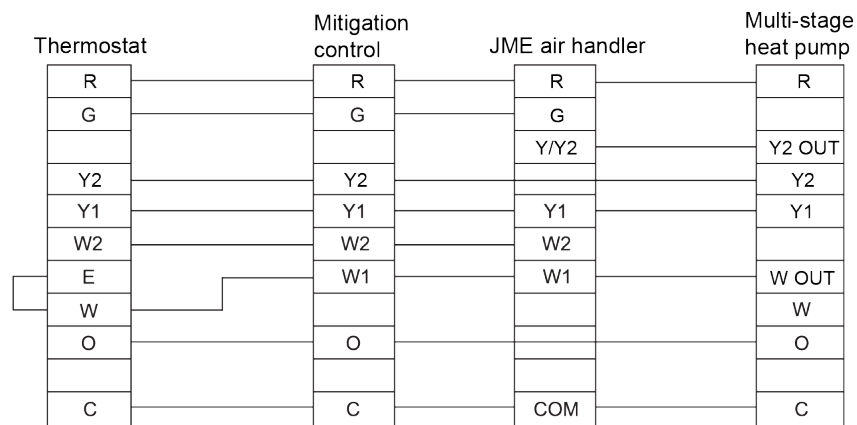

A2106-001

Table 10: Low-voltage wire connections

Wire	Connection
R	24V power
C	24V common
O	Reversing valve input
Y	1st stage compressor
Y2	2nd stage compressor (where applicable)
W	Auxiliary heat input (not always used)
WOUT	Auxiliary heat output (energized during defrost)
Y2OUT	High speed indoor airflow output

For full field low-voltage wiring, refer to the mitigation control kit and the indoor unit *Installation Manual*.

Using the optional S1-2HU16700124 dehumidification control

About this task:

The indoor unit *Installation Manual* for the air handler or furnace describes the interface with the outdoor heat pump. A dehumidification control accessory S1-2HU16700124 can be used with variable speed air handlers or furnaces in high humidity areas. This control works with the variable speed indoor unit to provide cooling at a reduced air flow, lowering evaporator temperature and increasing latent capacity. The humidistat in this control opens the humidistat contacts as the humidity increases. Installation instructions are packaged with the accessory.

1. Before the installation of the dehumidification control, the humidistat jumper must be set to **YES** on the indoor variable speed air handler or furnace control board.
2. During cooling, if the relative humidity in the space is higher than the desired set point of the dehumidification control, the variable speed blower motor operates at a lower speed until the dehumidification control is satisfied. Aim for a 40% to 60% relative humidity level to achieve optimum comfort.
3. If a dehumidification control is installed, it is recommended that a minimum air flow of 325 CFM/ton be supplied at all times.

Charging the system

CAUTION

If a field-installed device is placed in the inner-connecting refrigerant lines that can store a significant refrigerant charge, for example, a refrigerant mass flow meter or a liquid receiver, the unit may not perform as designed. If such a performance-affecting device is installed and it is possible to check the unit in heating mode, the unit pressures should be confirmed in heating mode. See *Heating charging charts*.

CAUTION

Refrigerant charging must be carried out by a licensed qualified air conditioning contractor.

CAUTION

Always charge in liquid form. Take care not to slug the compressor.

CAUTION

Compressor damage occurs if the system is inadequately charged. On new system installations, charge the system according to the *Tabular Data Sheet* for the matched coil and follow guidelines in this instruction.

Refer to the *Tabular Data Sheet* provided in the customer booklet for the unit for charge requirements. Permanently mark the total system charge on the unit data plate.

CAUTION

Do not leave the system open to the atmosphere. Unit damage could occur due to moisture being absorbed by the POE oil in the system. This type of oil is highly susceptible to moisture absorption.

The factory charge in the outdoor unit includes enough charge for the unit, 15 ft (4.6 m) of refrigerant piping, and the smallest indoor coil or air handler match-up. Some indoor coil or air handler matches may require additional charge.

- **Important:** Ensure that different refrigerants are not mixed when using charging equipment, and keep hoses or lines as short as possible to minimize refrigerant collecting in them.

Ensure that the refrigerating system is properly grounded before charging it with refrigerant.

To ensure that the unit performs at the published levels, it is important to determine the indoor airflow and add refrigerant charge accordingly. To charge the system, follow these steps:

1. Measure the indoor airflow.
2. Determine the total system charge.
3. Use the indoor airflow and total system charge results to charge the unit.
4. Label the system when the charging process is complete, if not already labeled.
5. Perform a leak test on the system after charging but before commissioning. Conduct a follow-up leak test before leaving the site. See [Checking for refrigerant leaks](#).

Measuring indoor airflow

About this task:

You need to measure the indoor airflow in order to charge the unit.

To determine the rated airflow for a specific match, refer to the technical literature available at <http://www.simplygettingthejobdone.com>. When attempting to match this airflow, select the lowest possible speed tap, measure the actual flow, and adjust as necessary.

To measure actual airflow, it is not an acceptable method to just check the jumper pin setting tables and assume 0.5 in. W.C total external static pressure.

To determine indoor airflow, follow these steps:

1. On a gas furnace or single-piece air handler, measure the static pressure with a manometer between the filter and return air opening of the indoor equipment. On a modular air handler, measure the return air static pressure between the indoor coil and entering air side of the modular air handler.
2. Perform a **or** b.
 - a. On a single-piece or modular air handler, take a second reading in the supply air ductwork leaving the indoor equipment.
 - b. On a gas furnace, take a second reading after the heat exchanger, but before the indoor coil.
3. Add the negative return static to the positive supply static to determine the total system static pressure. Treat the negative return static as a positive pressure, even though it is a negative reading.
4. If there is static pressure on the blower return (for example, -0.1 in. W.C.), add it to a supply static (0.4 in. W.C.) that equals the total system static pressure (0.5 in. W.C.).
5. Compare this value to the indoor blower performance charts, ensuring air flow is between 350 CFM to 450 CFM per ton of cooling.

Checking the indoor cubic feet per minute (CFM) settings

Refer to the indoor unit *Installation Manual* instructions for the air handler or furnace interface with the outdoor heat pump. Refer to the outdoor *Technical Guide* for the indoor airflow settings you should set for each specific heat pump. For the system to operate correctly, ensure that the indoor CFM selection is correct.

Determining the total system charge

1. Determine the outdoor unit factory charge using the *Tabular Data Sheet* (item 1).
2. Determine the indoor coil adjustment (if any) using the *Tabular Data Sheet* (item 2).
3. Calculate the additional charge for the refrigerant piping using the *Tabular Data Sheet* if the line length is greater than 15 ft (4.6 m) (item 3).

4. Note that the total system charge = item 1 + item 2 + item 3.
5. Check the unit against the pressure value listed on the cooling chart on the unit or the appropriate heat charging chart in this manual. Make any adjustment necessary.
6. Add or subtract refrigerant to obtain the pressure listed on the charging chart. Adjust the total system charge by the amount added or removed to obtain the charging chart pressures. Permanently mark the unit data plate with the total amount of refrigerant in the system.

 **WARNING**

Do not attempt to pump total system charge into outdoor unit for maintenance or service. This may cause damage to the compressor or other components. Recover and weigh system charge into an appropriate recovery cylinder for any instances requiring evacuation.

 **CAUTION**

It is unlawful to knowingly vent, release, or discharge refrigerant into the open air during repair, service, maintenance or the final disposal of this unit.

Charging with gauges

 **CAUTION**

Refrigerant charging must only be carried out by a qualified air conditioning contractor.

-  **Note:** All pressures and subcool values shown are with the compressor on high stage. The system must be charged with the compressor at full capacity.

All units include a cooling charging chart for the most common indoor application in upflow orientation. For all other cooling charging charts and the heating charging charts, see [Table 14](#) to [Table 43](#). You can also access these charts in the Service Application Data section at www.simplygettingthejobdone.com.

CAUTION

Compressor damage occurs if system is insufficiently charged. On new system installations, charge the system according to the *Tabular Data Sheet* for the matched coil and follow the guidelines in this manual.

To charge with gauges, follow these steps:

1. Before using the gauges, confirm that the gauges are accurate by comparing the gauges against a calibrated pressure gauge that has been calibrated against a national standard. If a calibrated pressure gauge is not available, place an R-454B virgin refrigerant container in a conditioned space long enough to come to temperature equilibrium with the surroundings. Then measure the temperature of the air and the pressure of the refrigerant and compare it to the following table:

Table 11: R-454B saturation properties

Pressure (psig)	Tsat liquid (bubble) (°F)	Tsat vapor (dew)
100	34	37
110	39	41
125	46	48
135	50	52
150	56	58
160	60	62
175	65	67
190	70	72
205	75	77
225	80	83
240	85	87
260	90	92
280	95	97
300	100	102
325	106	108
345	110	112
370	115	117
395	120	122
420	125	127
450	130	132
480	135	137
510	140	142

2. Locate the applicable cooling chart in [Table 14](#) to [Table 27](#) or heating chart in [Table 30](#) to [Table 43](#) for the indoor coil and orientation. Use the method outlined in [Measuring indoor airflow](#) to calculate the airflow, then consult the correct table and match the liquid pressure to that airflow.

Subcooling charging charts

-  **Note:** An asterisk (*) on indoor match names is used in place of the cabinet width, refrigerant type, and metering device characters. Refer to the indoor unit manuals for the details on indoor unit nomenclature.

Table 12: 1.5 ton cooling charging chart for JH(E,C)24*C and CT(F,M,U)30*C in upflow and horizontal left

Outdoor ambient DB (°F)	Indoor wet bulb (°F) at 80°F dry bulb			
	57	62	67	72
	Pressure (psig) and subcooling (°F) at liquid base valve			
55	186 (9)	188 (9)	191 (9)	193 (9)
60	203 (8)	205 (9)	208 (9)	210 (8)
65	219 (8)	222 (9)	224 (9)	227 (8)
70	236 (8)	239 (8)	241 (8)	244 (8)
75	253 (8)	255 (8)	258 (8)	261 (8)
80	274 (8)	276 (8)	279 (8)	282 (8)
85	295 (8)	297 (9)	300 (9)	303 (8)
90	316 (8)	318 (9)	321 (9)	324 (8)
95	337 (9)	338 (9)	342 (9)	345 (8)
100	364 (9)	364 (9)	368 (9)	372 (8)
105	390 (9)	390 (9)	394 (9)	398 (9)
110	416 (9)	416 (9)	420 (9)	424 (9)
115	442 (9)	442 (9)	446 (9)	450 (9)
120	469 (9)	469 (9)	472 (9)	476 (9)
125	495 (9)	495 (10)	498 (9)	502 (9)

Table 13: 1.5 ton cooling charging chart for JH(E,C)24*C and CT(F,M,U)30*C in downflow and horizontal right

Outdoor ambient DB (°F)	Indoor wet bulb (°F) at 80°F dry bulb			
	57	62	67	72
	Pressure (psig) and subcooling (°F) at liquid base valve			
55	189 (10)	191 (10)	194 (10)	196 (10)
60	206 (9)	208 (10)	211 (10)	213 (9)
65	222 (9)	225 (10)	227 (10)	231 (9)
70	240 (9)	242 (9)	245 (9)	248 (9)
75	257 (9)	259 (9)	262 (9)	265 (9)
80	278 (9)	280 (9)	283 (9)	286 (9)
85	300 (9)	302 (10)	305 (10)	308 (9)
90	321 (9)	322 (10)	326 (10)	329 (9)
95	342 (10)	343 (10)	347 (10)	350 (9)
100	369 (10)	370 (10)	374 (10)	377 (9)
105	396 (10)	396 (10)	400 (10)	404 (10)
110	422 (10)	422 (10)	427 (10)	431 (10)
115	449 (10)	449 (10)	453 (10)	457 (10)
120	476 (10)	476 (10)	479 (10)	483 (10)
125	503 (10)	503 (11)	506 (10)	510 (10)

Table 14: 2 ton cooling charging chart for JH(E,C)24*C and CT(F,M,U)30*C in upflow and horizontal left

Outdoor ambient DB (°F)	Indoor wet bulb (°F) at 80°F dry bulb			
	57	62	67	72
	Pressure (psig) and subcooling (°F) at liquid base valve			
55	192 (15)	196 (15)	198 (15)	200 (15)
60	211 (15)	214 (15)	216 (15)	219 (15)
65	229 (15)	232 (15)	235 (15)	238 (15)
70	247 (15)	250 (15)	253 (15)	257 (15)
75	266 (15)	268 (15)	271 (15)	275 (15)
80	288 (15)	290 (15)	294 (15)	298 (16)
85	311 (15)	312 (15)	316 (16)	321 (16)
90	333 (15)	334 (15)	339 (16)	344 (16)
95	355 (15)	356 (15)	362 (16)	367 (16)
100	385 (16)	386 (16)	391 (16)	397 (17)
105	415 (16)	415 (16)	421 (16)	427 (17)
110	445 (16)	445 (16)	451 (17)	457 (17)
115	475 (17)	475 (17)	480 (17)	487 (18)
120	505 (17)	505 (17)	510 (17)	517 (18)
125	535 (17)	534 (17)	540 (17)	547 (18)

Table 15: 2 ton cooling charging chart for JH(E,C)24*C and CT(F,M,U)30*C in downflow and horizontal right

Outdoor ambient DB (°F)	Indoor wet bulb (°F) at 80°F dry bulb			
	57	62	67	72
	Pressure (psig) and subcooling (°F) at liquid base valve			
55	190 (14)	193 (14)	196 (15)	198 (14)
60	208 (14)	211 (15)	214 (15)	217 (15)
65	226 (14)	229 (15)	232 (15)	235 (15)
70	245 (14)	247 (15)	250 (15)	254 (15)
75	263 (14)	265 (15)	268 (15)	272 (15)
80	285 (15)	286 (15)	290 (15)	295 (15)
85	307 (15)	308 (15)	313 (15)	317 (15)
90	329 (15)	330 (15)	335 (15)	340 (16)
95	352 (15)	352 (15)	357 (15)	363 (16)
100	381 (15)	381 (15)	387 (16)	392 (16)
105	411 (16)	411 (16)	416 (16)	422 (17)
110	440 (16)	440 (16)	446 (16)	452 (17)
115	470 (16)	470 (16)	475 (16)	482 (17)
120	499 (17)	499 (17)	504 (17)	512 (18)
125	529 (17)	528 (17)	534 (17)	541 (18)

Table 16: 3 ton cooling charging chart for JH(E,C)(30,36)*D and CT(F,M,U)(30,36)*D in upflow and horizontal left

Outdoor ambient DB (°F)	Indoor wet bulb (°F) at 80°F dry bulb			
	57	62	67	72
	Pressure (psig) and subcooling (°F) at liquid base valve			
55	193 (4)	195 (5)	198 (4)	201 (3)
60	211 (5)	213 (5)	216 (5)	220 (3)
65	228 (5)	231 (6)	235 (5)	238 (4)
70	246 (6)	248 (6)	253 (5)	257 (4)
75	264 (6)	266 (6)	271 (5)	276 (5)
80	285 (6)	288 (6)	293 (5)	298 (5)
85	307 (6)	309 (6)	315 (6)	319 (5)
90	328 (6)	331 (6)	336 (6)	341 (5)
95	350 (6)	352 (6)	358 (6)	363 (5)
100	378 (6)	379 (6)	385 (6)	391 (5)
105	405 (6)	406 (6)	412 (6)	418 (5)
110	433 (6)	433 (6)	439 (6)	445 (6)
115	461 (6)	460 (6)	466 (6)	472 (6)
120	488 (6)	487 (6)	493 (6)	499 (6)
125	516 (6)	514 (6)	520 (6)	526 (6)

Table 17: 3 ton cooling charging chart for JH(E,C)(30,36)*D and CT(F,M,U)(30,36)*D in downflow and horizontal right

Outdoor ambient DB (°F)	Indoor wet bulb (°F) at 80°F dry bulb			
	57	62	67	72
	Pressure (psig) and subcooling (°F) at liquid base valve			
55	191 (3)	193 (4)	196 (3)	199 (2)
60	209 (4)	211 (4)	214 (4)	218 (3)
65	226 (4)	229 (4)	233 (4)	236 (3)
70	244 (4)	246 (5)	251 (4)	255 (3)
75	261 (5)	264 (5)	269 (4)	273 (4)
80	283 (5)	285 (5)	290 (4)	295 (4)
85	304 (5)	307 (5)	312 (4)	317 (4)
90	326 (5)	328 (5)	333 (4)	339 (4)
95	347 (5)	349 (5)	355 (4)	360 (4)
100	374 (5)	376 (5)	382 (4)	387 (4)
105	402 (5)	403 (5)	408 (5)	414 (4)
110	429 (5)	430 (5)	435 (5)	441 (4)
115	457 (5)	456 (5)	462 (5)	468 (4)
120	484 (4)	483 (5)	489 (5)	495 (5)
125	512 (4)	510 (5)	516 (5)	522 (5)

Table 18: 3 ton cooling charging chart for JH(E,C)42°F and CT(F,M,U)48°F in upflow and horizontal left

Outdoor ambient DB (°F)	Indoor wet bulb (°F) at 80°F dry bulb			
	57	62	67	72
	Pressure (psig) and subcooling (°F) at liquid base valve			
55	198 (10)	200 (10)	203 (10)	207 (8)
60	216 (10)	219 (11)	222 (10)	226 (9)
65	235 (11)	237 (11)	241 (10)	245 (9)
70	253 (11)	255 (11)	260 (11)	264 (10)
75	271 (12)	274 (12)	279 (11)	283 (10)
80	293 (12)	296 (12)	301 (11)	306 (10)
85	315 (12)	318 (12)	323 (11)	328 (10)
90	338 (12)	340 (12)	346 (11)	351 (10)
95	360 (12)	362 (12)	368 (11)	374 (10)
100	388 (12)	390 (12)	396 (11)	401 (11)
105	417 (12)	418 (12)	423 (12)	429 (11)
110	445 (12)	445 (12)	451 (12)	457 (11)
115	473 (12)	473 (12)	479 (12)	485 (11)
120	502 (11)	501 (12)	507 (12)	513 (12)
125	530 (11)	528 (12)	534 (12)	541 (12)

Table 19: 3 ton cooling charging chart for JH(E,C)42°F and CT(F,M,U)48°F in downflow and horizontal right

Outdoor ambient DB (°F)	Indoor wet bulb (°F) at 80°F dry bulb			
	57	62	67	72
	Pressure (psig) and subcooling (°F) at liquid base valve			
55	193 (5)	195 (6)	198 (5)	201 (5)
60	211 (6)	213 (6)	217 (5)	220 (5)
65	229 (6)	231 (6)	235 (6)	239 (5)
70	247 (6)	249 (6)	254 (6)	258 (5)
75	264 (6)	267 (6)	272 (6)	276 (6)
80	286 (6)	289 (6)	294 (6)	298 (6)
85	308 (6)	310 (6)	315 (6)	320 (6)
90	329 (6)	332 (6)	337 (6)	342 (6)
95	351 (6)	353 (6)	359 (6)	364 (6)
100	379 (6)	380 (6)	386 (6)	392 (6)
105	406 (6)	407 (6)	413 (6)	419 (6)
110	434 (6)	434 (6)	440 (6)	446 (6)
115	462 (6)	461 (6)	467 (6)	473 (6)
120	490 (6)	488 (6)	494 (6)	501 (6)
125	517 (6)	515 (6)	521 (6)	528 (6)

Table 20: 4 ton cooling chart for JH(E,C)48°F and CT(F,M,U)60°F in upflow and horizontal left

Outdoor ambient DB (°F)	Indoor wet bulb (°F) at 80°F dry bulb			
	57	62	67	72
	Pressure (psig) and subcooling (°F) at liquid base valve			
55	199 (9)	202 (9)	206 (9)	210 (8)
60	217 (9)	219 (9)	223 (9)	228 (8)
65	234 (9)	237 (9)	241 (9)	246 (8)
70	252 (9)	254 (9)	259 (9)	264 (8)
75	269 (9)	272 (9)	277 (8)	282 (8)
80	292 (9)	294 (10)	299 (9)	304 (8)
85	314 (9)	316 (10)	321 (9)	327 (9)
90	336 (10)	338 (10)	344 (10)	349 (9)
95	359 (10)	360 (10)	366 (10)	372 (9)
100	388 (10)	389 (11)	395 (10)	401 (10)
105	418 (11)	418 (11)	424 (11)	431 (11)
110	448 (11)	447 (12)	454 (11)	460 (11)
115	477 (12)	476 (12)	483 (12)	490 (12)
120	507 (12)	505 (13)	512 (12)	519 (12)
125	536 (13)	534 (13)	541 (13)	549 (13)

Table 21: 4 ton cooling charging chart for JH(E,C)48*G and CT(F,M,U)60*G in downflow and horizontal right

Outdoor ambient DB (°F)	Indoor wet bulb (°F) at 80°F dry bulb			
	57	62	67	72
	Pressure (psig) and subcooling (°F) at liquid base valve			
55	212 (11)	215 (11)	219 (11)	223 (9)
60	231 (11)	233 (11)	238 (11)	242 (9)
65	249 (11)	252 (11)	257 (10)	262 (9)
70	268 (11)	271 (11)	276 (10)	281 (9)
75	287 (11)	289 (11)	295 (10)	300 (10)
80	310 (11)	313 (12)	318 (11)	324 (10)
85	334 (11)	336 (12)	342 (11)	348 (10)
90	358 (12)	360 (12)	366 (11)	372 (11)
95	382 (12)	384 (13)	390 (12)	396 (11)
100	414 (13)	415 (13)	421 (13)	427 (12)
105	445 (13)	445 (14)	452 (13)	459 (13)
110	477 (14)	476 (14)	483 (14)	490 (13)
115	508 (14)	507 (15)	514 (14)	522 (14)
120	540 (15)	538 (15)	545 (15)	553 (15)
125	571 (15)	569 (16)	576 (15)	584 (15)

Table 22: 4 ton cooling chart for JH(E,C)60*H and CT(F,M,U)60*H in upflow and horizontal left

Outdoor ambient DB (°F)	Indoor wet bulb (°F) at 80°F dry bulb			
	57	62	67	72
	Pressure (psig) and subcooling (°F) at liquid base valve			
55	199 (8)	201 (8)	205 (8)	209 (6)
60	216 (8)	219 (8)	223 (8)	227 (7)
65	234 (8)	236 (8)	241 (8)	245 (7)
70	251 (8)	254 (8)	258 (8)	263 (7)
75	269 (8)	271 (8)	276 (7)	281 (7)
80	291 (8)	293 (9)	298 (8)	304 (7)
85	313 (8)	315 (9)	321 (8)	326 (8)
90	336 (9)	338 (9)	343 (9)	349 (8)
95	358 (9)	360 (9)	365 (9)	371 (8)
100	388 (9)	389 (10)	394 (9)	401 (9)
105	417 (10)	418 (10)	424 (10)	430 (10)
110	447 (10)	447 (11)	453 (10)	460 (10)
115	476 (11)	476 (11)	482 (11)	489 (11)
120	506 (11)	504 (12)	511 (11)	518 (11)
125	535 (12)	533 (12)	540 (12)	548 (12)

Table 23: 4 ton cooling charging chart for JH(E,C)60*H and CT(F,M,U)60*H in downflow and horizontal right

Outdoor ambient DB (°F)	Indoor wet bulb (°F) at 80°F dry bulb			
	57	62	67	72
	Pressure (psig) and subcooling (°F) at liquid base valve			
55	198 (7)	200 (7)	204 (7)	208 (5)
60	215 (7)	218 (7)	222 (7)	226 (5)
65	232 (7)	235 (7)	239 (7)	244 (6)
70	250 (7)	253 (7)	257 (6)	262 (6)
75	267 (7)	270 (7)	275 (6)	280 (6)
80	290 (7)	292 (7)	297 (6)	302 (6)
85	312 (7)	314 (8)	319 (7)	324 (7)
90	334 (7)	336 (8)	341 (7)	347 (7)
95	356 (8)	358 (8)	363 (8)	369 (7)
100	386 (8)	387 (8)	392 (8)	399 (8)
105	415 (9)	415 (9)	421 (9)	428 (9)
110	445 (9)	444 (9)	450 (9)	457 (9)
115	474 (10)	473 (10)	479 (10)	486 (10)
120	504 (10)	502 (10)	508 (10)	516 (10)
125	533 (11)	531 (11)	537 (11)	545 (11)

Table 24: 5 ton cooling charging chart for JH(E,C)60*H and CT(F,M,U)60*H in upflow and horizontal left

Outdoor ambient DB (°F)	Indoor wet bulb (°F) at 80°F dry bulb			
	57	62	67	72
	Pressure (psig) and subcooling (°F) at liquid base valve			
55	195 (9)	197 (10)	199 (10)	202 (11)
60	212 (9)	214 (10)	217 (10)	220 (11)
65	229 (9)	231 (10)	235 (10)	238 (11)
70	246 (9)	249 (10)	253 (10)	257 (11)
75	263 (9)	266 (10)	271 (10)	276 (11)
80	285 (9)	288 (10)	293 (10)	298 (11)
85	307 (9)	310 (10)	315 (10)	321 (11)
90	329 (9)	332 (10)	337 (10)	343 (11)
95	351 (9)	353 (10)	359 (10)	365 (10)
100	379 (9)	380 (10)	387 (10)	393 (10)
105	407 (9)	408 (10)	414 (10)	421 (10)
110	435 (9)	435 (10)	442 (10)	448 (10)
115	463 (9)	462 (10)	469 (10)	476 (10)
120	491 (9)	489 (10)	497 (10)	504 (10)
125	519 (9)	516 (9)	524 (9)	531 (10)

Table 25: 5 ton cooling charging chart for JH(E,C)60*H and CT(F,M,U)60*H in downflow and horizontal right

Outdoor ambient DB (°F)	Indoor wet bulb (°F) at 80°F dry bulb			
	57	62	67	72
	Pressure (psig) and subcooling (°F) at liquid base valve			
55	192 (1)	194 (2)	196 (2)	198 (3)
60	208 (1)	211 (2)	213 (2)	216 (3)
65	225 (1)	228 (2)	231 (2)	235 (3)
70	242 (1)	245 (2)	249 (2)	253 (3)
75	259 (1)	262 (2)	267 (2)	272 (3)
80	281 (1)	283 (2)	288 (2)	294 (3)
85	303 (1)	305 (2)	310 (2)	316 (2)
90	324 (1)	326 (2)	332 (2)	338 (2)
95	346 (1)	348 (2)	354 (2)	360 (2)
100	373 (1)	374 (2)	381 (2)	387 (2)
105	401 (1)	401 (2)	408 (2)	414 (2)
110	428 (1)	428 (2)	435 (2)	441 (2)
115	456 (1)	455 (1)	462 (1)	469 (2)
120	483 (1)	481 (1)	489 (1)	496 (2)
125	511 (1)	508 (1)	516 (1)	523 (2)

Table 26: 5 ton cooling charging chart for JH(E,C)60*J and CT(F,M,U)60*J in upflow and horizontal left

Outdoor ambient DB (°F)	Indoor wet bulb (°F) at 80°F dry bulb			
	57	62	67	72
	Pressure (psig) and subcooling (°F) at liquid base valve			
55	193 (8)	195 (9)	198 (10)	199 (11)
60	210 (8)	213 (9)	216 (10)	218 (11)
65	227 (9)	230 (10)	233 (10)	237 (11)
70	245 (9)	247 (10)	251 (10)	255 (10)
75	262 (9)	265 (10)	269 (10)	274 (10)
80	283 (9)	286 (10)	291 (10)	296 (10)
85	305 (9)	308 (10)	313 (10)	319 (10)
90	327 (9)	329 (10)	335 (10)	341 (10)
95	349 (9)	351 (10)	357 (10)	363 (10)
100	377 (9)	378 (10)	384 (10)	390 (10)
105	404 (9)	405 (9)	412 (9)	418 (10)
110	432 (9)	432 (9)	439 (9)	445 (10)
115	460 (9)	459 (9)	466 (9)	473 (10)
120	488 (9)	486 (9)	493 (9)	500 (10)
125	515 (9)	513 (9)	521 (9)	528 (10)

Table 27: 5 ton cooling charging chart for JH(E,C)60*J and CT(F,M,U)60*J in downflow and horizontal right

Outdoor ambient DB (°F)	Indoor wet bulb (°F) at 80°F dry bulb			
	57	62	67	72
	Pressure (psig) and subcooling (°F) at liquid base valve			
55	197 (6)	199 (7)	201 (8)	203 (9)
60	214 (6)	217 (7)	219 (8)	222 (9)
65	231 (7)	234 (8)	237 (8)	241 (9)
70	249 (7)	252 (8)	256 (8)	260 (8)
75	266 (7)	269 (8)	274 (8)	279 (8)
80	289 (7)	291 (8)	296 (8)	302 (8)
85	311 (7)	313 (8)	318 (8)	324 (8)
90	333 (7)	335 (8)	341 (8)	347 (8)
95	355 (7)	357 (8)	363 (8)	369 (8)
100	383 (7)	385 (8)	391 (8)	397 (8)
105	411 (7)	412 (8)	419 (8)	425 (8)
110	440 (7)	440 (7)	447 (7)	453 (8)
115	468 (7)	467 (7)	474 (7)	481 (8)
120	496 (7)	495 (7)	502 (7)	509 (8)
125	524 (7)	522 (7)	530 (7)	537 (8)

Heating charging charts

① **Note:** An asterisk (*) on indoor match names is used in place of the cabinet width, refrigerant type, and metering device characters. Refer to the indoor unit manuals for the details on indoor unit nomenclature.

Table 28: 1.5 ton heating charging chart for JH(E,C)24*C and CT(F,M,U)30*C in upflow and horizontal left

CFM	Ambient temperature (°F)	60			47			40			30			17			10			0		
	Indoor temperature (°F)	60	70	80	60	70	80	60	70	80	60	70	80	60	70	80	60	70	80	60	70	80
450	Liquid pressure (subcool)	328 (18)	368 (18)	408 (19)	303 (22)	341 (23)	378 (23)	290 (25)	329 (25)	367 (26)	273 (27)	309 (28)	345 (29)	247 (28)	282 (30)	317 (32)	240 (32)	273 (33)	306 (34)	225 (41)	256 (37)	286 (34)
585	Liquid pressure (subcool)	297 (17)	336 (17)	375 (17)	276 (20)	306 (20)	351 (22)	267 (23)	304 (23)	341 (24)	253 (25)	288 (26)	324 (27)	232 (26)	261 (28)	301 (30)	223 (23)	257 (27)	292 (31)	214 (39)	245 (35)	276 (32)
750	Liquid pressure (subcool)	266 (16)	303 (16)	341 (16)	249 (18)	286 (19)	323 (20)	244 (21)	280 (22)	316 (22)	232 (23)	268 (24)	303 (25)	218 (25)	251 (26)	285 (28)	205 (14)	241 (22)	278 (29)	203 (36)	234 (33)	266 (29)
—	Suction pressure	125	126	127	101	101	103	89	90	91	74	75	75	59	57	58	51	50	50	38	39	39

Table 29: 1.5 ton heating charging chart for JH(E,C)24*C and CT(F,M,U)30*C in downflow and horizontal right

CFM	Ambient temperature (°F)	60			47			40			30			17			10			0		
	Indoor temperature (°F)	60	70	80	60	70	80	60	70	80	60	70	80	60	70	80	60	70	80	60	70	80
450	Liquid pressure (subcool)	343 (22)	384 (22)	426 (23)	316 (27)	356 (28)	395 (28)	303 (31)	344 (31)	383 (32)	285 (33)	323 (34)	360 (35)	258 (31)	295 (33)	331 (35)	251 (35)	285 (36)	320 (37)	235 (45)	268 (41)	299 (37)
600	Liquid pressure (subcool)	313 (22)	355 (22)	396 (22)	291 (26)	323 (26)	370 (29)	282 (30)	321 (30)	360 (31)	267 (32)	304 (34)	342 (35)	244 (28)	275 (31)	317 (33)	235 (25)	270 (29)	307 (34)	225 (42)	258 (38)	290 (35)
750	Liquid pressure (subcool)	281 (21)	320 (21)	360 (21)	263 (23)	302 (24)	341 (26)	258 (27)	296 (28)	334 (28)	245 (30)	283 (31)	320 (32)	223 (24)	257 (26)	291 (27)	209 (14)	246 (21)	284 (28)	207 (35)	239 (32)	272 (28)
—	Suction pressure	127	128	129	103	103	105	91	92	93	75	76	76	60	58	59	52	51	51	39	40	40

Table 30: 2 ton heating charging chart for JH(E,C)24*C and CT(F,M,U)30*C in upflow and horizontal left

CFM	Ambient temperature (°F)	60			47			40			30			17			10			0		
	Indoor temperature (°F)	60	70	80	60	70	80	60	70	80	60	70	80	60	70	80	60	70	80	60	70	80
600	Liquid pressure (subcool)	340 (29)	385 (31)	431 (32)	316 (31)	360 (34)	402 (35)	303 (32)	345 (34)	386 (36)	285 (34)	324 (35)	364 (37)	252 (32)	293 (37)	324 (35)	239 (32)	274 (34)	308 (36)	236 (42)	272 (44)	307 (46)
800	Liquid pressure (subcool)	307 (25)	349 (26)	391 (28)	286 (26)	323 (30)	370 (31)	275 (27)	317 (30)	357 (32)	261 (29)	300 (31)	340 (34)	239 (31)	275 (36)	314 (36)	230 (32)	266 (35)	302 (37)	227 (40)	262 (42)	297 (45)
1000	Liquid pressure (subcool)	273 (20)	312 (21)	351 (23)	255 (21)	298 (25)	337 (26)	247 (22)	288 (25)	328 (28)	236 (24)	276 (27)	316 (30)	226 (30)	265 (33)	304 (37)	220 (31)	257 (35)	295 (38)	217 (37)	252 (40)	287 (43)
—	Suction pressure	123	124	124	99	99	100	88	88	88	73	73	73	56	54	56	48	48	48	38	38	38

Table 31: 2 ton heating charging chart for JH(E,C)24*C and CT(F,M,U)30*C in downflow and horizontal right

CFM	Ambient temperature (°F)	60			47			40			30			17			10			0		
	Indoor temperature (°F)	60	70	80	60	70	80	60	70	80	60	70	80	60	70	80	60	70	80	60	70	80
600	Liquid pressure (subcool)	410 (50)	465 (51)	519 (53)	381 (52)	433 (54)	484 (56)	366 (53)	416 (55)	466 (57)	343 (55)	391 (56)	439 (58)	308 (54)	352 (56)	396 (57)	293 (54)	335 (56)	378 (58)	275 (55)	316 (57)	357 (59)
800	Liquid pressure (subcool)	373 (46)	425 (47)	476 (49)	348 (48)	389 (49)	450 (52)	335 (49)	385 (51)	435 (54)	317 (51)	366 (53)	415 (55)	287 (49)	337 (53)	376 (54)	275 (50)	318 (53)	362 (55)	264 (53)	305 (55)	346 (58)
1000	Liquid pressure (subcool)	336 (42)	384 (43)	432 (45)	314 (43)	364 (46)	415 (48)	304 (44)	354 (47)	404 (50)	290 (46)	340 (49)	390 (52)	265 (44)	310 (47)	356 (50)	257 (45)	301 (49)	345 (52)	252 (50)	293 (53)	335 (56)
—	Suction pressure	121	121	122	97	97	98	86	86	87	72	72	72	56	56	57	48	49	49	38	38	38

Table 32: 3 ton heating charging chart for JH(E,C)(30,36)*D and CT(F,M,U)(30,36)*D in upflow and horizontal left

CFM	Ambient temperature (°F)	60			47			40			30			17			10			0		
	Indoor temperature (°F)	60	70	80	60	70	80	60	70	80	60	70	80	60	70	80	60	70	80	60	70	80
900	Liquid pressure (subcool)	312 (12)	352 (14)	393 (16)	288 (16)	324 (17)	365 (20)	276 (18)	314 (20)	352 (22)	260 (21)	297 (23)	334 (26)	241 (25)	276 (27)	314 (30)	233 (28)	268 (30)	304 (32)	220 (36)	255 (39)	290 (41)
1200	Liquid pressure (subcool)	285 (11)	324 (13)	364 (14)	266 (15)	298 (15)	342 (19)	256 (17)	294 (19)	332 (21)	243 (20)	280 (22)	317 (25)	229 (23)	260 (24)	302 (28)	222 (25)	257 (28)	293 (30)	211 (34)	245 (37)	279 (39)
1500	Liquid pressure (subcool)	258 (10)	296 (11)	334 (12)	243 (13)	279 (14)	319 (17)	236 (15)	273 (17)	311 (19)	226 (19)	263 (21)	300 (23)	217 (20)	251 (22)	289 (25)	211 (22)	246 (25)	282 (27)	201 (32)	234 (35)	268 (37)
—	Suction pressure	113	114	115	91	91	92	80	80	81	66	66	66	53	54	53	45	46	46	34	35	36

Table 33: 3 ton heating charging chart for JH(E,C)(30,36)*D and CT(F,M,U)(30,36)*D in downflow and horizontal right

CFM	Ambient temperature (°F)	60			47			40			30			17			10			0		
	Indoor temperature (°F)	60	70	80	60	70	80	60	70	80	60	70	80	60	70	80	60	70	80	60	70	80
900	Liquid pressure (subcool)	310 (4)	350 (6)	391 (7)	286 (8)	325 (10)	363 (12)	274 (10)	312 (12)	350 (14)	259 (13)	296 (15)	332 (17)	244 (13)	280 (15)	317 (17)	235 (15)	271 (18)	307 (20)	223 (20)	259 (23)	295 (25)
1200	Liquid pressure (subcool)	286 (4)	325 (6)	365 (7)	266 (8)	299 (10)	343 (12)	257 (10)	294 (12)	332 (14)	244 (13)	281 (15)	318 (18)	232 (13)	265 (15)	305 (17)	225 (15)	261 (18)	297 (20)	214 (18)	249 (21)	284 (23)
1500	Liquid pressure (subcool)	261 (4)	300 (6)	338 (7)	246 (8)	284 (10)	322 (11)	239 (10)	276 (12)	314 (14)	229 (13)	266 (15)	303 (18)	220 (12)	257 (14)	293 (17)	215 (14)	250 (17)	286 (20)	204 (16)	238 (19)	273 (21)
—	Suction pressure	110	111	112	88	88	89	78	78	78	64	64	65	52	52	53	45	46	46	36	36	37

Table 34: 3 ton heating charging chart for JH(E,C)42*F and CT(F,M,U)48*F in upflow and horizontal left

CFM	Ambient temperature (°F)	60			47			40			30			17			10			0		
	Indoor temperature (°F)	60	70	80	60	70	80	60	70	80	60	70	80	60	70	80	60	70	80	60	70	80
900	Liquid pressure (subcool)	312 (15)	352 (16)	392 (17)	288 (18)	324 (19)	365 (22)	276 (21)	314 (22)	352 (24)	260 (24)	297 (26)	334 (28)	241 (28)	276 (30)	314 (32)	233 (30)	268 (33)	304 (35)	218 (34)	253 (37)	288 (39)
1200	Liquid pressure (subcool)	285 (14)	324 (15)	363 (16)	266 (17)	295 (18)	342 (21)	256 (20)	294 (21)	331 (23)	243 (23)	280 (25)	317 (27)	229 (24)	259 (28)	302 (29)	222 (26)	257 (29)	293 (31)	209 (32)	243 (35)	277 (37)

Table 34: 3 ton heating charging chart for JH(E,C)42°F and CT(F,M,U)48°F in upflow and horizontal left

CFM	Ambient temperature (°F)	60			47			40			30			17			10			0		
	Indoor temperature (°F)	60	70	80	60	70	80	60	70	80	60	70	80	60	70	80	60	70	80	60	70	80
1500	Liquid pressure (subcool)	258 (12)	296 (13)	334 (14)	243 (16)	278 (17)	318 (19)	236 (18)	273 (20)	310 (22)	226 (21)	263 (23)	299 (25)	217 (19)	251 (22)	289 (25)	211 (22)	246 (24)	282 (27)	199 (30)	232 (32)	266 (35)
—	Suction pressure	113	114	114	90	90	91	79	80	80	65	66	66	52	52	53	45	46	46	35	36	37

Table 35: 3 ton heating charging chart for JH(E,C)42°F and CT(F,M,U)48°F in downflow and horizontal right

CFM	Ambient temperature (°F)	60			47			40			30			17			10			0		
	Indoor temperature (°F)	60	70	80	60	70	80	60	70	80	60	70	80	60	70	80	60	70	80	60	70	80
900	Liquid pressure (subcool)	314 (11)	355 (12)	396 (13)	290 (15)	329 (16)	368 (18)	278 (17)	316 (18)	355 (20)	262 (20)	300 (22)	337 (24)	242 (19)	279 (21)	315 (24)	234 (22)	270 (24)	305 (27)	218 (21)	253 (24)	288 (27)
1200	Liquid pressure (subcool)	288 (10)	327 (11)	367 (12)	268 (14)	300 (15)	345 (17)	259 (16)	296 (17)	335 (19)	246 (19)	283 (21)	320 (23)	229 (18)	262 (20)	301 (23)	222 (20)	258 (23)	293 (26)	209 (19)	243 (22)	277 (25)
1500	Liquid pressure (subcool)	261 (9)	299 (10)	338 (11)	246 (12)	284 (14)	322 (16)	239 (14)	276 (16)	314 (18)	229 (17)	266 (20)	303 (22)	216 (16)	251 (19)	287 (21)	210 (18)	245 (21)	281 (24)	199 (17)	233 (20)	266 (23)
—	Suction pressure	115	116	117	92	93	93	81	81	82	67	67	67	53	54	54	45	46	47	36	37	38

Table 36: 4 ton heating charging chart for JH(E,C)48°F and CT(F,M,U)60°F in upflow and horizontal left

CFM	Ambient temperature (°F)	60			47			40			30			17			10			0		
	Indoor temperature (°F)	60	70	80	60	70	80	60	70	80	60	70	80	60	70	80	60	70	80	60	70	80
1200	Liquid pressure (subcool)	347 (18)	391 (18)	436 (18)	321 (22)	364 (22)	409 (22)	323 (40)	365 (41)	408 (42)	290 (24)	331 (25)	372 (26)	259 (22)	296 (24)	333 (27)	225 (1)	258 (2)	291 (3)	258 (33)	297 (33)	335 (33)
1600	Liquid pressure (subcool)	315 (18)	358 (18)	401 (18)	295 (21)	330 (21)	379 (21)	306 (38)	348 (39)	390 (40)	268 (22)	309 (23)	349 (24)	245 (21)	281 (23)	319 (26)	213 (2)	245 (3)	277 (3)	245 (31)	283 (31)	321 (32)
2000	Liquid pressure (subcool)	282 (17)	324 (17)	366 (17)	268 (20)	308 (20)	349 (20)	288 (35)	330 (37)	372 (38)	246 (19)	286 (21)	326 (22)	231 (19)	268 (22)	305 (24)	201 (3)	231 (3)	262 (3)	232 (28)	269 (29)	306 (30)
—	Suction pressure	118	119	120	94	96	97	78	79	80	70	70	70	53	54	53	49	48	47	36	36	36

Table 37: 4 ton heating charging chart for JH(E,C)48°F and CT(F,M,U)60°F in downflow and horizontal right

CFM	Ambient temperature (°F)	60			47			40			30			17			10			0		
	Indoor temperature (°F)	60	70	80	60	70	80	60	70	80	60	70	80	60	70	80	60	70	80	60	70	80
1200	Liquid pressure (subcool)	420 (35)	474 (36)	528 (36)	388 (39)	416 (39)	495 (40)	391 (57)	442 (59)	494 (60)	352 (42)	401 (43)	450 (43)	322 (40)	355 (42)	414 (45)	280 (20)	321 (20)	361 (21)	294 (42)	338 (42)	382 (42)
1600	Liquid pressure (subcool)	382 (34)	434 (34)	487 (34)	357 (37)	392 (36)	460 (38)	371 (54)	422 (56)	473 (57)	326 (38)	375 (40)	424 (40)	301 (37)	333 (38)	392 (42)	261 (19)	301 (19)	339 (19)	279 (40)	322 (40)	365 (41)
2000	Liquid pressure (subcool)	343 (32)	394 (32)	445 (32)	326 (35)	375 (35)	424 (35)	350 (50)	401 (52)	452 (53)	299 (34)	348 (36)	397 (37)	279 (34)	324 (36)	369 (39)	242 (17)	280 (17)	317 (17)	264 (37)	306 (38)	348 (39)
—	Suction pressure	116	118	119	93	95	96	77	78	79	69	69	70	51	49	50	47	46	45	35	35	36

Table 38: 4 ton heating charging chart for JH(E,C)60*H and CT(F,M,U)60*H in upflow and horizontal left

CFM	Ambient temperature (°F)	60			47			40			30			17			10			0		
	Indoor temperature (°F)	60	70	80	60	70	80	60	70	80	60	70	80	60	70	80	60	70	80	60	70	80
1200	Liquid pressure (subcool)	327 (9)	369 (9)	412 (10)	302 (13)	344 (13)	385 (14)	289 (15)	330 (16)	371 (16)	274 (16)	312 (17)	351 (17)	258 (21)	294 (21)	331 (22)	244 (21)	279 (22)	314 (23)	229 (23)	264 (23)	298 (24)
1600	Liquid pressure (subcool)	297 (10)	338 (10)	379 (10)	278 (13)	310 (13)	358 (14)	268 (15)	307 (15)	346 (15)	254 (15)	292 (16)	330 (16)	242 (19)	271 (19)	312 (20)	230 (20)	265 (20)	299 (21)	218 (21)	252 (21)	285 (22)
2000	Liquid pressure (subcool)	267 (10)	307 (10)	346 (10)	254 (13)	292 (13)	330 (13)	247 (15)	284 (14)	321 (14)	233 (13)	271 (14)	309 (15)	225 (17)	259 (17)	293 (17)	216 (18)	250 (18)	283 (18)	206 (19)	239 (19)	272 (20)
—	Suction pressure	117	118	119	94	95	96	81	83	84	69	70	70	54	53	53	44	44	43	35	35	36

Table 39: 4 ton heating charging chart for JH(E,C)60*H and CT(F,M,U)60*H in downflow and horizontal right

CFM	Ambient temperature (°F)	60			47			40			30			17			10			0		
	Indoor temperature (°F)	60	70	80	60	70	80	60	70	80	60	70	80	60	70	80	60	70	80	60	70	80
1200	Liquid pressure (subcool)	387 (34)	437 (35)	487 (35)	358 (38)	384 (38)	456 (39)	342 (40)	391 (41)	440 (41)	324 (41)	370 (42)	416 (42)	302 (40)	329 (39)	387 (41)	285 (41)	327 (41)	368 (42)	262 (41)	301 (42)	340 (43)
1600	Liquid pressure (subcool)	353 (34)	402 (34)	450 (34)	331 (37)	362 (37)	425 (37)	318 (39)	365 (39)	412 (39)	301 (38)	347 (39)	392 (40)	282 (37)	311 (35)	365 (38)	269 (38)	310 (38)	349 (39)	251 (38)	289 (39)	327 (39)
2000	Liquid pressure (subcool)	319 (33)	366 (32)	413 (32)	303 (35)	348 (35)	394 (35)	294 (37)	339 (37)	383 (37)	278 (35)	323 (36)	368 (38)	262 (34)	302 (34)	342 (34)	253 (34)	292 (34)	330 (35)	239 (35)	276 (35)	313 (35)
—	Suction pressure	115	117	118	93	93	95	80	82	83	68	69	69	53	53	52	43	42	42	30	28	27

Table 40: 5 ton heating charging chart JH(E,C)60*H and CT(F,M,U)60*H in upflow and horizontal left

CFM	Ambient temperature (°F)	60			47			40			30			17			10			0		
	Indoor temperature (°F)	60	70	80	60	70	80	60	70	80	60	70	80	60	70	80	60	70	80	60	70	80
1500	Liquid pressure (subcool)	346 (27)	390 (28)	435 (28)	325 (31)	369 (32)	412 (33)	313 (32)	354 (33)	396 (35)	293 (32)	337 (34)	381 (37)	272 (35)	311 (37)	350 (39)	261 (36)	296 (36)	331 (36)	247 (31)	286 (32)	326 (33)
1750	Liquid pressure (subcool)	327 (27)	370 (28)	414 (28)	308 (30)	351 (32)	394 (33)	298 (31)	338 (32)	380 (34)	281 (31)	323 (33)	365 (36)	261 (33)	298 (34)	341 (38)	252 (34)	289 (35)	325 (35)	239 (29)	277 (30)	316 (32)
2000	Liquid pressure (subcool)	307 (26)	350 (27)	393 (28)	290 (28)	333 (30)	375 (32)	282 (29)	322 (31)	363 (32)	268 (30)	308 (32)	349 (34)	250 (31)	290 (34)	331 (36)	242 (31)	281 (33)	319 (34)	231 (26)	268 (28)	306 (31)
—	Suction pressure	107	110	113	86	87	89	77	78	79	64	65	65	48	49	48	41	42	43	35	36	37

Table 41: 5 ton heating charging chart JH(E,C)60*H and CT(F,M,U)60*H in downflow and horizontal right

CFM	Ambient temperature (°F)	60			47			40			30			17			10			0		
	Indoor temperature (°F)	60	70	80	60	70	80	60	70	80	60	70	80	60	70	80	60	70	80	60	70	80
1500	Liquid pressure (subcool)	361 (29)	408 (30)	455 (31)	340 (34)	385 (35)	431 (36)	327 (35)	370 (36)	413 (37)	307 (35)	352 (37)	398 (39)	283 (31)	324 (33)	365 (36)	271 (32)	308 (32)	345 (33)	256 (34)	296 (35)	337 (36)
1750	Liquid pressure (subcool)	342 (29)	388 (30)	435 (31)	323 (33)	364 (34)	413 (35)	312 (34)	355 (35)	398 (36)	295 (34)	339 (36)	383 (38)	272 (30)	312 (32)	354 (35)	261 (30)	300 (31)	339 (33)	248 (32)	287 (33)	327 (35)

Table 41: 5 ton heating charging chart JH(E,C)60*H and CT(F,M,U)60*H in downflow and horizontal right

CFM	Ambient temperature (°F)	60			47			40			30			17			10			0		
	Indoor temperature (°F)	60	70	80	60	70	80	60	70	80	60	70	80	60	70	80	60	70	80	60	70	80
2000	Liquid pressure (subcool)	323 (29)	368 (29)	414 (30)	306 (31)	350 (32)	395 (34)	296 (32)	339 (33)	382 (35)	282 (32)	325 (34)	367 (36)	260 (28)	301 (31)	343 (33)	251 (28)	291 (30)	332 (32)	239 (29)	278 (31)	317 (34)
—	Suction pressure	113	116	119	91	92	94	81	82	83	68	68	69	55	55	55	47	48	49	36	37	38

Table 42: 5 ton heating charging chart for JH(E,C)60*J and CT(F,M,U)60*J in upflow and horizontal left

CFM	Ambient temperature (°F)	60			47			40			30			17			10			0		
	Indoor temperature (°F)	60	70	80	60	70	80	60	70	80	60	70	80	60	70	80	60	70	80	60	70	80
1500	Liquid pressure (subcool)	316 (24)	357 (25)	398 (26)	297 (28)	337 (29)	377 (30)	286 (29)	324 (31)	362 (32)	268 (29)	308 (31)	348 (34)	252 (31)	289 (33)	325 (36)	242 (32)	274 (32)	307 (33)	227 (33)	254 (31)	281 (29)
1750	Liquid pressure (subcool)	298 (24)	338 (24)	378 (25)	281 (27)	317 (28)	359 (29)	271 (28)	309 (29)	346 (31)	256 (28)	295 (30)	333 (32)	241 (30)	277 (32)	315 (35)	233 (30)	266 (31)	301 (32)	220 (31)	250 (30)	280 (29)
2000	Liquid pressure (subcool)	279 (23)	318 (23)	358 (24)	264 (25)	303 (27)	341 (28)	256 (26)	293 (27)	330 (29)	244 (27)	281 (29)	317 (30)	230 (28)	267 (30)	305 (33)	223 (28)	258 (30)	294 (31)	212 (28)	246 (29)	279 (29)
—	Suction pressure	107	110	112	86	87	89	76	78	79	64	65	65	48	47	48	40	41	42	30	32	34

Table 43: 5 ton heating charging chart for JH(E,C)60*J and CT(F,M,U)60*J in downflow and horizontal right

CFM	Ambient temperature (°F)	60			47			40			30			17			10			0		
	Indoor temperature (°F)	60	70	80	60	70	80	60	70	80	60	70	80	60	70	80	60	70	80	60	70	80
1500	Liquid pressure (subcool)	360 (33)	407 (34)	453 (35)	339 (37)	384 (38)	430 (39)	326 (38)	369 (40)	412 (41)	306 (38)	351 (40)	397 (43)	288 (37)	329 (39)	371 (42)	276 (38)	313 (38)	350 (39)	259 (39)	290 (37)	320 (35)
1750	Liquid pressure (subcool)	341 (32)	387 (33)	432 (34)	322 (36)	362 (36)	412 (38)	311 (37)	353 (38)	396 (40)	294 (37)	337 (39)	381 (41)	274 (35)	311 (35)	358 (39)	264 (35)	303 (36)	342 (37)	250 (36)	284 (35)	318 (34)
2000	Liquid pressure (subcool)	321 (31)	366 (32)	411 (33)	304 (34)	348 (35)	393 (37)	295 (35)	337 (36)	380 (38)	281 (35)	323 (37)	365 (39)	260 (32)	302 (34)	344 (36)	252 (32)	292 (33)	333 (35)	240 (32)	278 (32)	316 (33)
—	Suction pressure	114	117	120	92	93	95	81	83	84	68	69	70	52	53	52	44	45	46	32	35	38

Starting up the system

Before you begin:

When the outdoor unit is in place and the refrigerant piping and wiring are complete, you must start up the system and make sure that the system is operating correctly.

CAUTION

Do not operate the system until all the checks outlined in this procedure have been performed.

WARNING

Do not touch any of the parts at the discharge gas side by hand. The compressor chamber and the pipes at the discharge side are heated to temperatures higher than 194°F (90°C).

To start up the system, do the following:

1. Check to ensure that the service base valves of the outdoor unit are fully open.
2. Check to ensure that the electric wires are fully connected.
3. Use the thermostat to turn on the system.
4. Make sure that the system is operating correctly.

 **Note:** See [System components and operation](#) for more information about the system if needed.

Energizing the crankcase heater (if applicable)

To energize the crankcase heater, set the indoor thermostat to the **OFF** position. Close the line power disconnect to the unit. Where applicable, the outdoor unit has a CCH thermostat that opens at 45°F and closes at 35°F outdoor ambient temperature.

NOTICE

An attempt to start the compressor at low ambient conditions without at least 8 h of crankcase heat may damage the compressor. Installation of an accessory crankcase heater is required if not factory installed for installations over the maximum allowable line length.

With power to the unit and the thermostat in the cooling position, follow these steps:

1. In the cooling cycle, discharge gas is pumped to the outdoor coil which is the condenser. The indoor coil is the evaporator.
2. If the fan switch is in the **ON** position, a circuit is made through the blower relay to provide continuous blower operation.
3. With the fan switch in the **AUTO** position, a circuit is made from the thermostat cooling contact through the blower relay to provide blower operation.
4. The system cycles with thermostat demand to provide cooling as needed.

Instructing the owner

When installation and start-up is complete, instruct the owner on the following:

- Processing warranty cards or online registration
- Reviewing the *User's Information Manual*
- Operating and maintaining the unit correctly, how to start, stop, and adjust the temperature setting
- When applicable, instruct the owner that the compressor is equipped with a crankcase heater to prevent the migration of refrigerant to the compressor during the OFF cycle. The heater is energized only when the unit is not operating. If the main switch is disconnected for long periods of shut down, do not attempt to start the unit until 8 h after the switch has been connected. This allows sufficient time for all liquid refrigerant to be driven out of the compressor.
- The installer must also instruct the owner on correct operation and maintenance of all other system components.

Maintenance and repair

Before you begin:

- The area must be checked with an appropriate refrigerant detector prior to and during work, to ensure the technician is aware of potentially toxic or flammable atmospheres. **No Smoking** signs must be displayed.
- Ensure that the leak detection equipment being used is suitable for use with all applicable refrigerants, and be non-sparking, adequately sealed, and intrinsically safe.
- Be aware that equipment malfunction may be due to refrigerant loss and potential leaks.
- If any hot work is to be conducted on the refrigerating equipment or any associated parts, appropriate fire extinguishing equipment must be available to hand. Have a dry powder or CO2 fire extinguisher adjacent to the charging area.
- Initial safety check must include:
 - * Ensure that capacitors are discharged to avoid the possibility of sparking.
 - * Ensure that no live electrical components and wiring are exposed while charging, recovering or purging the system.
 - * Ensure that there is continuity of earth bonding.
- Repair and maintenance to electrical components must include initial safety checks and component inspection procedures.
- During repairs to sealed components, all electrical supplies must be disconnected from the equipment being worked upon prior to any removal of sealed covers. If it is absolutely necessary to have an electrical supply to equipment during servicing, then a permanently operating form of leak detection shall be located at the most critical point to warn of a potentially hazardous situation.
- For sealed electrical components such as capacitors, only replace components with parts specified by the manufacturer. Using other parts may lead to the ignition of refrigerant in the atmosphere in the case of a leak.
- For compressor evacuation, ensure compressors and compressor oils are properly evacuated to remove any flammable refrigerants. The compressor body must not be heated by an open flame or other ignition sources to accelerate this process.

- Ensure that the recovery equipment is in good working order and suitable for recovering flammable refrigerants.
- Always recover the refrigerant charge into the correct recovery cylinders if venting is not allowed by local and national codes.
- Ensure that cylinders are labelled for the recovered refrigerant, and that they have pressure-relief valves and working shut-off valves.

⚠ CAUTION

Risk of fire

Ensure that the outlet for the vacuum pump is not near potential ignition sources and has ventilation available

It is important to maintain the unit correctly, adhere to the following:

- Do not allow dirt to accumulate on the outdoor coils or other parts in the air circuit. Clean the unit as often as necessary. Use a brush, vacuum cleaner attachment, or other suitable means.
- The outdoor fan motor bearings are permanently lubricated and do not require periodic oiling.
- If the coil needs to be cleaned, it must be washed with water or with Nu-Calgon Cal-Green (or equivalent). If using coil cleaner, follow the directions included with it. Rinse thoroughly with clean water after use. Do not use a high pressure power washer on the coil or fin damage may occur.
- The indoor coil and drain pan must be inspected and cleaned regularly to prevent odors and ensure adequate drainage. Refer to the furnace or air handler *Installation Manual* for filter and blower motor maintenance.

What to do next:

- ⓘ **Note:** Refer to the furnace or air handler *Installation Manual* for filter and blower motor maintenance.

⚠ CAUTION

It is unlawful to knowingly vent, release or discharge refrigerant into the open air during repair, service, maintenance, or the final disposal of this unit.

Required procedures for A2L systems

The following procedures are required for A2L systems:

Table 44: A2L required procedures

Procedure	A2L
Safely remove refrigerant, following local and national codes.	Required
Purge circuit with inert gas (oxygen-free nitrogen).	Required
Evacuate the refrigerant.	Required

Table 44: A2L required procedures

Procedure	A2L
Repair the system and purge with nitrogen during brazing.	Required
Leak test and pressure test the unit.	Required
Evacuate the system.	Required
Charge the system.	Required

Decommissioning

Before you begin:

Before attempting the procedure, complete the following:

- Ensure that the technician is completely familiar with the equipment and all its detail.
- Ensure to safely recover all refrigerants.
- Take an oil and refrigerant sample, in case analysis is required before reusing the recovered refrigerant.
- Ensure that electrical power is available.
- Ensure that mechanical handling equipment is available, if required, for handling refrigerant cylinders.
- Ensure that all personal protective equipment is available and being used correctly.
- Ensure that the recovery process is supervised at all times by a competent person.
- Ensure that recovery equipment and cylinders conform to the appropriate standards.

Follow the steps below to ensure the unit is correctly and safely decommissioned:

1. Isolate the system electrically.
2. Connect a recovery machine to remove refrigerant from the system.
3. Ensure that the cylinder is situated on the scales before recovery takes place.
4. Start the recovery machine and operate in accordance with instructions provided with the machine.
 - ① **Note:**
 - Do not overfill cylinders to more than 80% volume liquid charge.
 - Do not exceed the maximum working pressure of the cylinder, even temporarily.
5. When the cylinders have been filled correctly and the process completed, ensure that the cylinders and the equipment are removed from the site promptly and that all isolation valves on the equipment are closed off.
 - ① **Note:** Do not charge recovered refrigerant into another refrigerating system unless it has been cleaned and checked.

What to do next:

Label the equipment stating that it has been decommissioned and emptied of refrigerant. Date and sign the label. For appliances containing flammable refrigerants, ensure that there are labels on the equipment stating that the equipment contains a flammable refrigerant.

Test input

The control includes a TEST input connector that can be used for various testing functions during installation and service. The TEST input connector is shown in [Figure 20](#). [Table 45](#) summarizes the behavior of the control when the two TEST pins are connected. More detailed descriptions of the various functions are included in other sections of this document.

Table 45: TEST input functionality with Y

Duration of connections	Control behavior with thermostat signals present
< 2	No response
2 to 5	Bypass ASCD (Reduce timer to zero immediately). If Y1 is present and high-pressure switch is closed, contactor is energized. If Y2 is also present, second stage output (M2) will also be energized.
	Clear pressure switch lockout and reset the 6 h PS timer.
> 5	Initiate defrost cycle ignoring the COIL temp and record that defrost cycle was initiated by TEST short. Energize Wout and begin defrost cycle immediately upon expiration of timer.
Test pin short removed	Terminate defrost as normal.
Test pin short not removed	Continue defrost cycle until TEST connection removed.

Table 46: TEST input functionality without Y

Duration of connections	Control behavior with thermostat signals not present
< 2	No response
2 to 5	The control flashes sequentially on the STATUS LED the series of stored error codes (up to the last five since active error codes were last cleared) starting with the most recent. If there are no error codes stored in memory, the STATUS LED flashes three times (0.1 s ON / 0.1 s OFF).
> 5	The control immediately clears the stored error code array, resets the 6 h PS timer and flashes the STATUS LED six times (0.1 s ON / 0.1 s OFF) to indicate that the error memory is clear.

Figure 19: Heat pump flow diagram

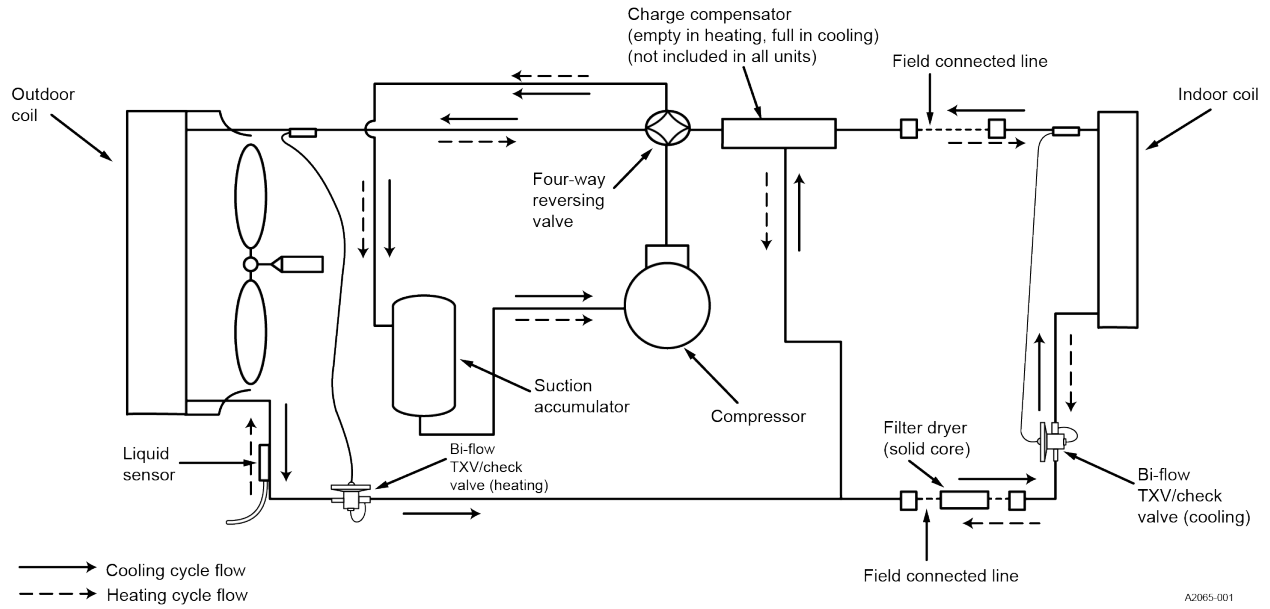
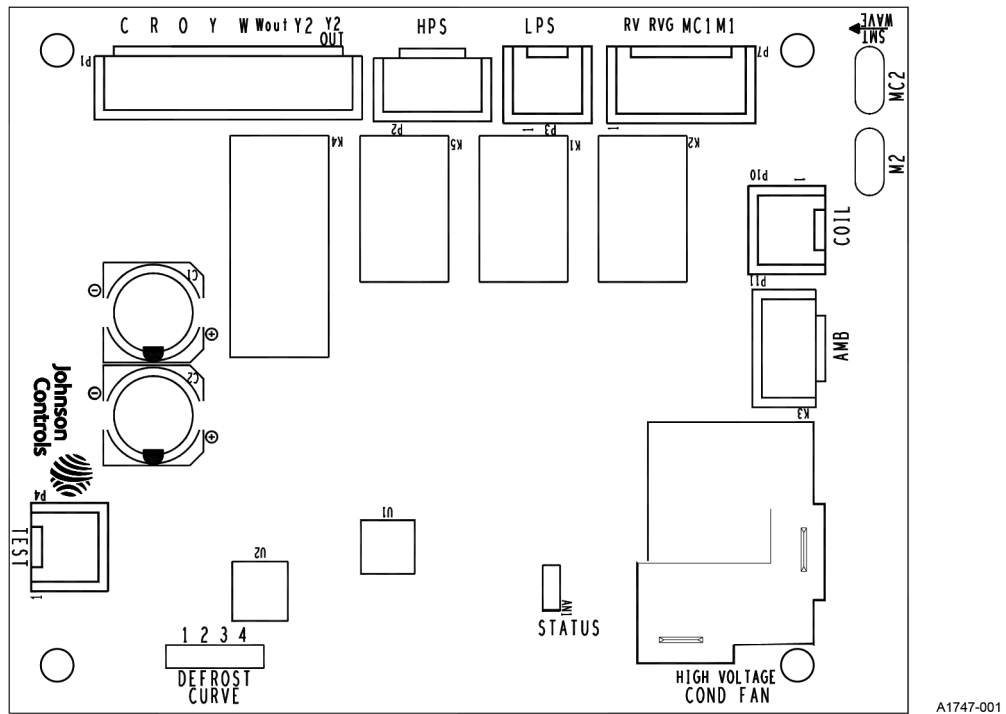

Figure 20: Demand defrost control module



System components and operation

Anti-short-cycle delay

The control includes a 5 min anti-short-cycle delay (ASCD) timer to prevent the compressor from short-cycling after a power or thermostat signal interruption. The ASCD timer is applied when the control is first powered from the indoor unit thermostat and immediately following the completion of a compressor run cycle. The compressor and the outdoor fan do not operate during the 5 min that the timer is active.

The ASCD timer can be bypassed by shorting the TEST terminals for 3 s while the thermostat is calling for compressor operation (Y input signal energized).

Low voltage detection

The control monitors the transformer secondary (24 VAC) voltage and provides low voltage protection for the heat pump and its components. In particular, the control prevents contactor chatter during low voltage conditions. If the voltage drops below approximately 19 VAC, the control continues to energize any relays that are already energized but does not energize any additional relays until the voltage level increases. If the voltage drops below approximately 16 VAC, the control immediately de-energizes the relay outputs and does not energize any relays until the voltage level increases.

Fault code display

The control provides status codes using the LED. Status codes indicate the state of unit operation but do not represent a fault. The following table describes the LED displayed during status codes. Status codes are not displayed when a fault code is present.

Table 47: Status code display

No power to the control	No faults active Nothing energized	OFF
Compressor operation active	No faults active M energized	ON
Control normal operation – no call for compressor	No faults active Y not present	2 s ON/2 s OFF
Control normal operation – in ASCD period	No faults active, Y present, ASCD timer not expired	0.1 s ON/0.1 s OFF

The control provides fault codes using the Status LED. [Table 48](#) describes the LED displays during fault codes. Unless otherwise specified, the control provides flashes that are a 1/3 s on and 1/3 s off for fault codes. The control only displays a single fault code on the LED. The control displays the fault code on the LED repeatedly with a 2 s off period between repetitions of the fault code. If multiple fault codes are present at the same time, the LED displays only the most recent fault.

[Table 48](#) shows the number of flashes for the specified code. For instance, a flash code entry of 3 indicates that the control energizes the output for three 1/3 s on, 1/3 s off flashes, waits 2 s, then energizes the output for three more 1/3 s on, 1/3 s off flashes and repeats.

Table 48: Faults

Description	Status LED
High-pressure switch fault (not in lockout yet)	2 flashes
System in high-pressure switch lockout (last mode of operation was normal compressor)	3 flashes
System in high-pressure switch lockout (last mode of operation was defrost)	4 flashes
System in low-pressure switch lockout (last mode of operation was normal compressor)	5 flashes
Low voltage (<19.2 VAC) preventing further relay outputs for > 2 s	6 flashes
Low voltage (<16 VAC) stopped current relay outputs for > 2 s	7 flashes
Coil sensor failure (open or shorted) - Comp. allowed/lockout	8 flashes
Outdoor ambient sensor failure (open or shorted) - Compressor allowed if coil is > 32°F	9 flashes
Control failure	10 flashes
W and O signal received at the same time	11 flashes
Y2 signal received without a Y	12 flashes

Demand defrost

The control maintains correct airflow through the outdoor coil during heating operation by melting frost and ice that may form on the coil. Frost may accumulate unevenly in different sections of the coil because of the arrangement of the refrigeration circuit within the coil. The control may initiate a defrost cycle even when the coil is not completely covered with frost. This is normal operation.

The control regulates the defrost operation of the heat pump based on accumulated compressor runtime, outdoor coil temperature, and outdoor ambient temperature. The control causes the heat pump unit to operate in the normal heating mode until it determines that a defrost cycle is needed.

Operating demand defrost

The defrost mode is equivalent to the cooling mode except that the outdoor fan motor is de-energized and the W out terminal is energized. The control must do the following to initiate a defrost cycle:

- Energize high indoor airflow through the Y2 out terminal.
- Energize high compressor speed through the M2 terminal (if not already in second stage).
- De-energize the outdoor fan.
- Energize the reversing valve.
- Energize the auxiliary heat output through the Wout terminal.
- Begin the maximum defrost cycle length timer.

If the call for heating (Y) is removed from the control during the defrost cycle, it terminates the defrost cycle and de-energize the compressor. The control also stops the defrost cycle length timer but does not reset it. When the control receives another call for heating, it restarts the defrost cycle and the timer at the point at which the call for heating was removed. This happens only if the coil sensor temperature conditions allow defrost to occur.

Defrost curves

The control uses a set of defrost curve parameters that are selected using the defrost curve selection jumper. The location of the defrost curve selection jumper is shown in the *Tabular Data Sheet* or [Table 49](#) for each heat pump model.

Defrost curve selection

The second page of the *Tabular Data Sheet* or [Table 49](#) indicates the correct jumper setting for the specific heat pump model.

The control only reads the jumper input when the Y and W thermostat inputs are de-energized. If a jumper position is changed while either of these inputs is energized, the control does not act upon the jumper changes until the thermostat calls are de-energized or power (24 VAC) to the control is cycled.

Table 49: Defrost jumper pin settings

Outdoor unit	18	24	36	48	60
Defrost jumper pin setting	2	2	2	3	2

Defrost cycle initiation

The control allows the heat pump to operate in the heating mode until the combination of outdoor ambient and outdoor coil temperatures indicate that a defrost cycle is necessary.

The control initiates a defrost cycle when the coil temperature is below the initiate point for the measured ambient temperature continuously for 4 1/2 min. See [Figure 21](#). This delay eliminates unnecessary defrost cycles caused by refrigeration surges such as those that occur at the start of a heating cycle.

The control initiates a defrost cycle every 6 h (accumulated compressor runtime) to recirculate refrigerant lubricants. This forced defrost timer resets and restarts following the completion or termination of a defrost cycle.

The control initiates a defrost cycle when the Defrost Inhibit Time Limit elapses if the previous defrost cycle was terminated based on the Maximum Defrost Cycle Time. This occurs regardless of the liquid line (coil) temperature reading. The coil does not have to be cold for the unit to be forced into defrost. When the defrost cycle begins, the control follows the normal defrost cycle routine.

The control also initiates a defrost cycle when the TEST terminals are shorted. This feature allows an installer or service technician to start a defrost cycle immediately as required. When the TEST terminals are shorted for more than 5 s with a Y input energized and the pressure switch input is closed, the ASCD is bypassed, the reversing valve is energized, the ODF is de-energized, and the compressor and the Wout terminal to auxiliary heat are energized.

When the TEST inputs are used to force a defrost cycle, the control ignores the state of the coil temperature and outdoor ambient temperature inputs. The coil does not have to be cold and the outdoor temperature does not have to be within a certain range for the heat pump to be forced into a defrost cycle. After the TEST input jumper is removed, the defrost mode terminates as normal. The defrost cycle length timer does not start until the TEST input is removed. If the TEST terminals remain shorted, the control keeps the unit in defrost mode.

Defrost inhibition

The control does not initiate a defrost cycle if the liquid line temperature is above 32°F (40°F for curve 4), unless the defrost cycle is forced using the TEST input, or the previous defrost exited on the maximum time of 14 min.

The control also prevents a defrost cycle from being initiated too soon after the initiation of the previous defrost cycle. When power is applied to the control and after the completion or termination of each defrost cycle, the control starts a 40 min timer. When this timer expires, the

control allows another defrost cycle when needed. The timer is based on accumulated compressor runtime.

Defrost termination

The control terminates the defrost cycle immediately after the liquid line temperature reaches the terminate temperature or after 14 min of defrost operation. See [Figure 21](#).

The control does the following to terminate a defrost cycle:

- Energize the outdoor fan.
- De-energize the reversing valve.
- De-energize the auxiliary heat output through the W out terminal.
- Reset and restart the 40 min defrost inhibit timer.

Figure 21: Defrost operation curves

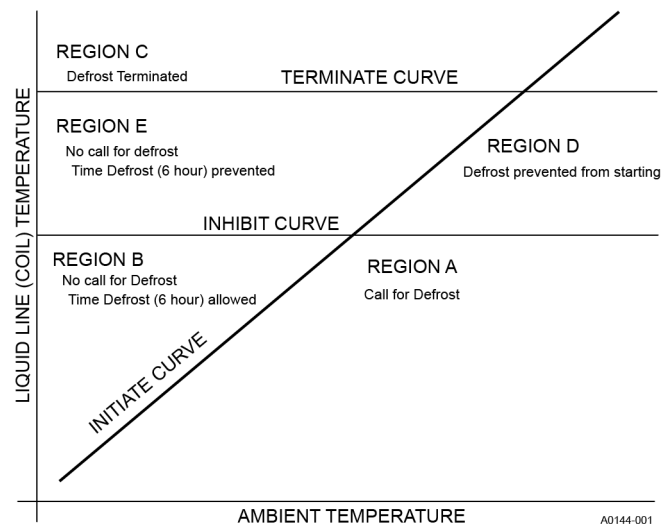

Cooling operation

During cooling operation, the control receives thermostat signals at the Y (Y + Y2 for 2nd stage), and O input terminals. The control energizes the M (M + M2 for 2nd stage) compressor output terminal. This signal energizes the coil of the compressor contactor causing the compressor to operate. The control also delivers power to the COND FAN terminals causing the outdoor fan to operate. The control energizes the REV VALVE terminal with 24 VAC to switch the reversing valve.

Heating operation

During normal heating mode, the control receives a thermostat signal at the Y (Y + Y2 for 2nd stage) input terminal. The control energizes the M (M + M2 for 2nd stage) compressor output terminal. This signal energizes the coil of the compressor contactor causing the compressor to operate. The control also delivers power to the COND FAN terminals causing the outdoor fan to operate. The reversing valve is not energized in heating mode.

In low ambient conditions (<40°F) the control energizes M2 and Y2 out, forcing second stage operation for the remainder of the call.

Emergency heat

When the thermostat calls for emergency heat operation (W signal without a Y signal), the control energizes the W out terminal immediately.

Pressure switch fault detection and lockout

The heat pump is equipped with a high pressure switch and low pressure switch that connect to the control at the pressure switch terminals. If the high pressure switch input opens for more than 40 ms, the control de-energizes the compressor. If the switch is closed and a thermostat call for compressor operation is present, the control applies the 5 min anti-short-cycle delay timer and starts the compressor when the timer expires.

If the low pressure switch opens for 5 s under conditions when the control is not ignoring the low pressure switch input, the control enters a low pressure switch fault. The control ignores the low pressure switch input during the following conditions:

- Defrost operation
- The first 120 s of compressor operation
- 120 s following the completion of a defrost cycle
- When the outdoor ambient temperature is below 5 °F

When the compressor starts after a switch fault, the control starts a 6 h timer based on accumulated compressor runtime. If the control senses another opening of the switch before the timer expires, it causes a soft lockout condition. The second opening of the switch must be greater than 160 ms for the lockout to occur. If the second opening is between 40 ms and 160 ms, the control de-energizes the compressor but does not cause a soft lockout condition. If the control does not sense a second switch opening before the 6 h timer expires, the timer and counter reset.

During the soft lockout mode, the control de-energizes the compressor and energizes the LED output with the appropriate flash code.

The control resets the soft lockout condition when any of the following occur after removal of the fault condition:

- Power is cycled to the R or Y inputs of the control. This causes the soft lockout condition to be reset when the thermostat is satisfied or when the thermostat is set to SYSTEM OFF and back to HEAT or COOL mode.
- The TEST terminals short for more than 2 s.
When the soft lockout condition is reset, the control stops displaying the fault code and responds to thermostat inputs normally.

Third-party trademarks notice

Third-Party Trademarks Notice: For information about third-party trademarks, refer to the relevant company websites.

Wiring diagrams

Figure 22: Wiring diagram - single-phase - 208/230V PSC fan motor

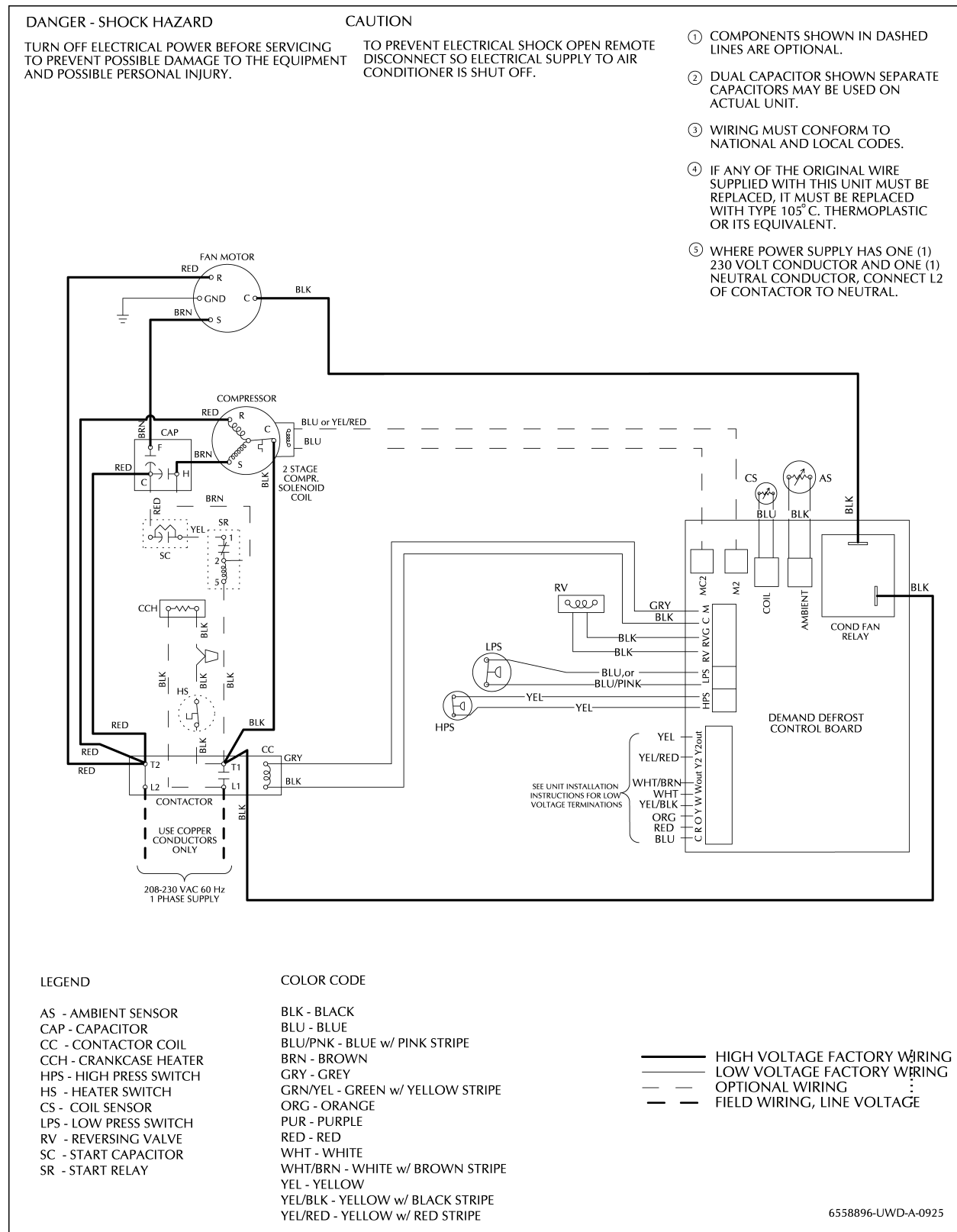
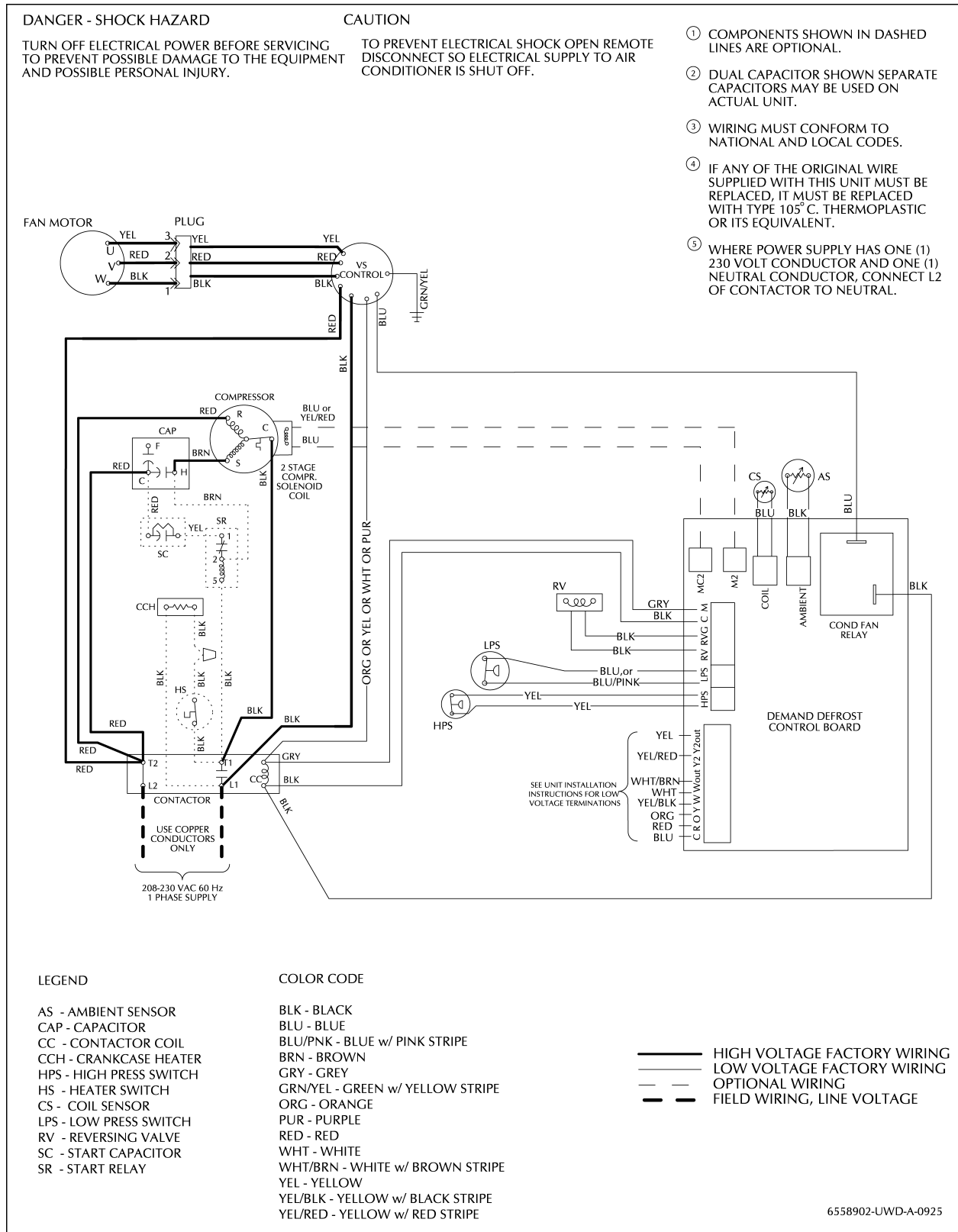

Figure 23: Wiring diagram - single-phase - 208/230V ECM fan motor



Start-up sheet

Heat Pump and Supplementary Heat Start-up Sheet

Correct start-up is critical to customer comfort and equipment longevity

Start-up date
Technician performing start-up Installing contractor name

Owner information

Name Address
City State or province Zip or postal code

Equipment data

Upflow Downflow Horizontal left Horizontal right

Indoor unit model no. Indoor unit serial no.
Indoor coil model no. Indoor coil serial no.
Outdoor unit model no. Outdoor unit serial no.

Filter, thermostat, and accessories

Filter type Filter size Filter locations
Thermostat type Other system equipment and accessories

Connections in accordance with installation instructions and local codes

Unit is level Supply plenum and return ducts are connected and sealed Refrigerant piping complete and leak-tested
 Gas piping is connected (if applicable) Vent system is connected (if applicable)
 Condensate drain for indoor coil correctly connected Condensate drain for furnace (if applicable)

Electrical: line voltage

Indoor unit (VAC) Outdoor unit (VAC) Overcurrent protection breaker/fuses (A)
 Ground wire is connected Polarity is correct (120 VAC indoor units), black is L1 (hot), white is N (neutral)

Electrical: low voltage

Thermostat wiring complete Heat anticipator is set to the recommended value listed in the installation instructions
Low voltage values: R and C at indoor unit control board (VAC)
R and C at outdoor unit control board (VAC) Heat anticipator recommended value

Supplementary heating set-up

Heating type: Electric air handler Natural gas LP gas (requires LP conversion kit)
Inlet gas pressure (in. W.C.) Manifold gas pressure (in. W.C.) LP gas conversion kit part no. used
Calculated input in Btu/h - clock the gas meter (natural gas only) LP kit installed by
Electric heat kit part no. (if applicable) kW installed Rated Btu/h (furnaces)

Venting (if applicable)

Venting system correctly sized within the limitations of the charts in the installation instructions
Intake size No. of 90° elbows No. of 45° elbows Length
Exhaust size No. of 90° elbows No. of 45° elbows Length

Page 1 of 2 (9/24/21)

Air side: system total external static pressure

Supply static before indoor coil (in. W.C.)	<input type="text"/>	Supply static after indoor coil (in. W.C.)	<input type="text"/>
Return static (in. W.C.) before filter	<input type="text"/>	Return static (in. W.C.) after filter (furnace side)	<input type="text"/>
Total external static pressure (ESP)	<input type="text"/>	Maximum rated ESP (in. W.C.)	<input type="text"/>

Airflow setup

Blower type and set-up	Variable speed ECM <small>(circle 0 or 1)</small>	Heat	0 / 1	0 / 1							
		Low cool	0 / 1	0 / 1	0 / 1						
		High cool	0 / 1	0 / 1	0 / 1						
		Delay	0 / 1	0 / 1							
		Stage 1 kW	0 / 1	0 / 1							
	Heat kit selection		0 / 1	0 / 1	0 / 1	0 / 1					
	Standard ECM	Compressor high	<input type="radio"/> 1	<input type="radio"/> 2	<input type="radio"/> 3	<input type="radio"/> 4	<input type="radio"/> 5	<input type="radio"/> 6	<input type="radio"/> 7	<input type="radio"/> 8	<input type="radio"/> 9
		Compressor low	<input type="radio"/> 1	<input type="radio"/> 2	<input type="radio"/> 3	<input type="radio"/> 4	<input type="radio"/> 5	<input type="radio"/> 6	<input type="radio"/> 7	<input type="radio"/> 8	<input type="radio"/> 9
		Continuous fan	<input type="radio"/> 1	<input type="radio"/> 2	<input type="radio"/> 3	<input type="radio"/> 4	<input type="radio"/> 5	<input type="radio"/> 6	<input type="radio"/> 7	<input type="radio"/> 8	<input type="radio"/> 9
		Electric heat	<input type="radio"/> 1	<input type="radio"/> 2	<input type="radio"/> 3	<input type="radio"/> 4	<input type="radio"/> 5	<input type="radio"/> 6	<input type="radio"/> 7	<input type="radio"/> 8	<input type="radio"/> 9

Supply static (in. W.C.)	<input type="text"/>	Supply air dry bulb temperature	<input type="text"/>	Outside air dry bulb temperature	<input type="text"/>
Return static (in. W.C.)	<input type="text"/>	Return air dry bulb temperature	<input type="text"/>	Return air wet bulb temperature	<input type="text"/>
Total external static pressure	<input type="text"/>	Temperature drop	<input type="text"/>	Supply air wet bulb temperature	<input type="text"/>

Defrost control board

Fill in ON, OFF, or the appropriate value for the fields that apply to the installed defrost control board.

Two stage Demand defrost Variable capacity Time and temperature

Low temperature cut out Balance point Defrost curve Y2 lock FFUEL Switch point

Hot heat pump Bonnet sensor present Runtime (time and temperature board): only 30 min, 60 min, or 90 min

Refrigerant charge and metering device

Additional refrigeration piping length Adder per lb-ft oz

R-410A TXV Fixed orifice

No. of elbows No. of 45s Total added: lb oz

Orifice size Suction line temperature (°F) High side pressure Low side pressure

TXV No. Liquid line temperature (°F) Subcooling Superheat

Cycle test

Operate the unit through several heating cycles from the thermostat, noting and correcting any problems.

Operate the unit through continuous fan cycles from the thermostat, noting and correcting any problems.

Operate the unit through a cooling cycle, noting and correcting any problems.

Operate the unit through an emergency heating cycle, noting and correcting any problems.

Clean up

Installation debris disposed of, and indoor and outdoor areas cleaned up

Owner education

Provide the owner with the owner's manual.

Explain operation of the system to the owner.

Explain thermostat use and programming (if applicable) to the owner.

Explain the importance of regular filter replacement and equipment maintenance.

Comments section